

FABRIC BUILDING INSTRUCTIONS

MODEL: SH-RO203015

L9.2 x W6.1 x H 4.6



PICTURE MAY NOT REFLECT THE EXACT MODEL

TO OUR NEW AND VALUED CUSTOMER

Thank you for purchasing your new Instant Shelter. We know you will have as much pleasure owning your new shelter as we had in making it for you. Our shelters have been designed for rapid assembly and minimal maintenance. We have rigorous quality control at every step of the shelters manufacturing process to insure you the best unit money can buy. Our parts are triple checked prior to packaging to insure you will have everything you need before you start. In the unlikely event that a part is damaged or missing, you should immediately contact your place of purchase for a speedy replacement.

About Safety

HEAD PROTECTION IS RECOMMENDED!

Working with or under heavy parts included with this shelter can cause serious head injury.

WEAR GLOVES

You will be working with metal parts which may have SHARP edges

CHECK WITH YOUR LOCAL AUTHORITIES

Underground POWER CABLES or GAS LINES may result in injury while securing the shelter. It may also result in having to move the building. A cursory check with the local building authorities will help alleviate these concerns.

CLIMBING EQUIPMENT

It is highly recommended that scaffolding, ladders and mechanical lifting equipment conform to all local building codes when erecting the shelter. Safety straps and harnesses should be used at all times. The metal structure of the shelter has not been designed for human weight. Erecting shelter during wind or rain is unsafe and could result in serious injury.

CHECK LOCAL WEATHER CONDITIONS

Check your local weather forecast prior to planning your building day. Wind, snow and/or rain may cause unsafe conditions that could lead to serious injury.

STORING HAZARDOUS MATERIALS

Check all local building codes prior to storing any hazardous material. Shelter may require additional ventilation to meet local codes.

SEVERE WEATHER CONDITIONS

Working in and around the portable shelter during severe weather is not recommended. Serious injury could result. In the event that extraordinarily severe wind, snow or other severe conditions are predicted and if time permits, it is recommended that the shelter cover be removed.

PREVENT ENTRAPMENT

Check Shelter for co workers before locking up. Always provide for escape in case of emergency.

SHELTER RELOCATION

Should the shelter require relocation or disassembly for any reason, it is strongly recommended that the structure and its cover are thoroughly inspected prior to rebuilding.

PERIODIC SHELTER INSPECTION

As with all structures, periodic inspection of the cover and all structural-components is highly recommended. Tightening the cover and the structure will prolong the life of your investment.

PLEASE BE **Safety** CONSCIOUS!









Common Sense is the knack of seeing things as they are, and doing things as they ought to be done.

THANK YOU FOR CHOOSING OUR SHELTER

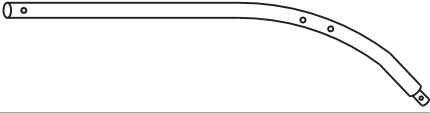

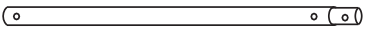
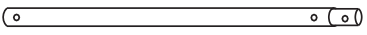
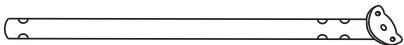
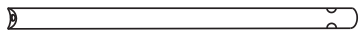
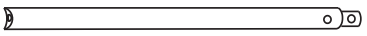
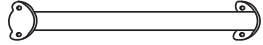
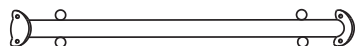
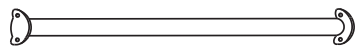
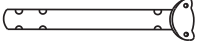

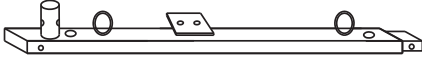
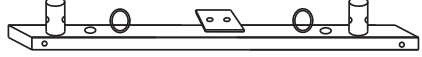

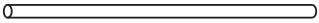
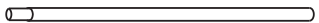

UNPACKING & IDENTIFYING PARTS

Prior to assembling your New Portable Shelter, unpack all crates and complete an inventory of all parts according to the following list and diagrams

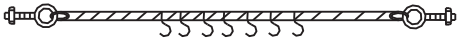

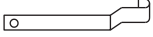

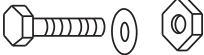
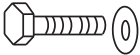
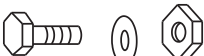
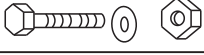

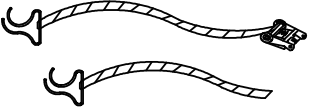
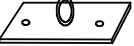
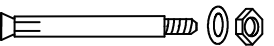
PARTS LIST FOR SH-RO203015

Parts#	Descriptions	Diagram	Dimensions (mm)	Q'TY	BOX
1	Top roof arched rafter(left)		Φ60x1600	6	1
2	Roof arched rafter		Φ60x1600	14	1
3	Lower Roof arched rafter(end)		Φ60x1600	4	1
4	Side upper curved rafter		Φ60x1450	8	1
5	Side upper curved rafter(end)		Φ60x1450	4	1
6	Side vertical rafter(leg)		Φ60x1800	12	2
7	Inside door vertical tube(lower)		Φ60x2000	4	3
8	Inside door vertical tube(upper)		Φ60x2035	4	3
9	Upper door cross tube		Φ60x1800	2	2
10	Upper door cross tube		Φ60x1800	2	2
11	Side door frame cross support tube		Φ45x1035	4	2
12	Top and side roof purlin		Φ45x1770	15	2
13	Purlin		Φ45x1770	20	2
14	Upper door vertical support		Φ60x770	2	2
15	Door frame base rail		90x30x1180	4	2
16	Side base rail		90x30x1824	8	2
17	Side base rail		90x30x1924	2	2
18	Upper door vertical support connector		Φ60/4x60x150	2	1

PARTS LIST FOR SH-RO203015

Parts#	Descriptions	Diagram	Dimensions (mm)	Q'TY	BOX
19	Cover conduit		Φ25x1860	2	3
20	Cover conduit		Φ25x1860	8	3
21	Zipper tool(open/close)		Φ16x1800	1	3
22	Fixer (for door frame)		Φ60/4x60x130	30	1
23	Door sliding cableS:14pcs		Φ6x3600	2	1
24	Roof bracing cable kit		Φ6x3600	20	1
25	Side wall bracing cable kit		Φ6x3230	20	1
26	Door sliding cable support hook		3x25x200	2	1
27	Ratchet tie-down			10	1
28	Anchor		M16x450	24	1
29	Screw, washer and nut		M8x85	138	1
30	Screw and washer for door frame and door base rail		M8x85	8	1
31	Screw, washer and nut for ratchet		M8x20	20	1
32	Screw, washer and nut		M8x110	8	1
33	Screws for door base		M8x110	4	1
34	Door bracing cable kit		Φ6x4850	4	1
35	Wind bracing strap			3	1
36	Base (for #35)			6	1
37	Door Wedge anchor(for#36)		M12x120	12	1

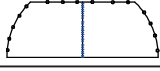
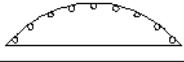
PARTS LIST FOR SH-RO203015

Parts#	Descriptions	Diagram	Dimensions (mm)	Q'TY	BOX
38	Ball type bungee		Φ 5x380	76	1
39	Cover lock-up		T-2	48	1
40	Strap band(for ratchet)			10	1
41	Main Cover			1	3
42	Door cover			2	3
43	Upper cover			2	3
44	Wrench		13-16	2	1

PARTS LIST FOR SH-RO203015

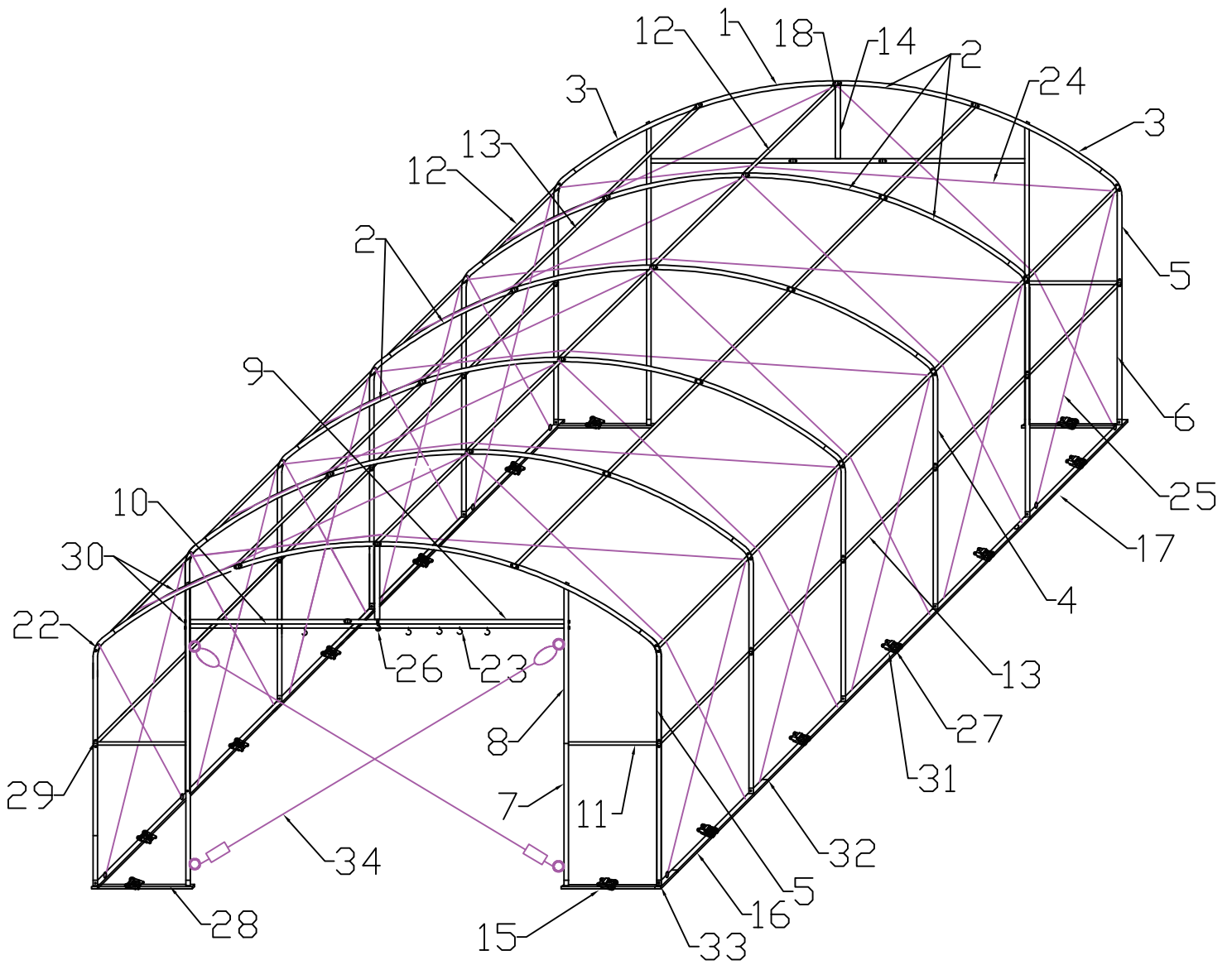

SH-RO203015 Main Dimension(mm)

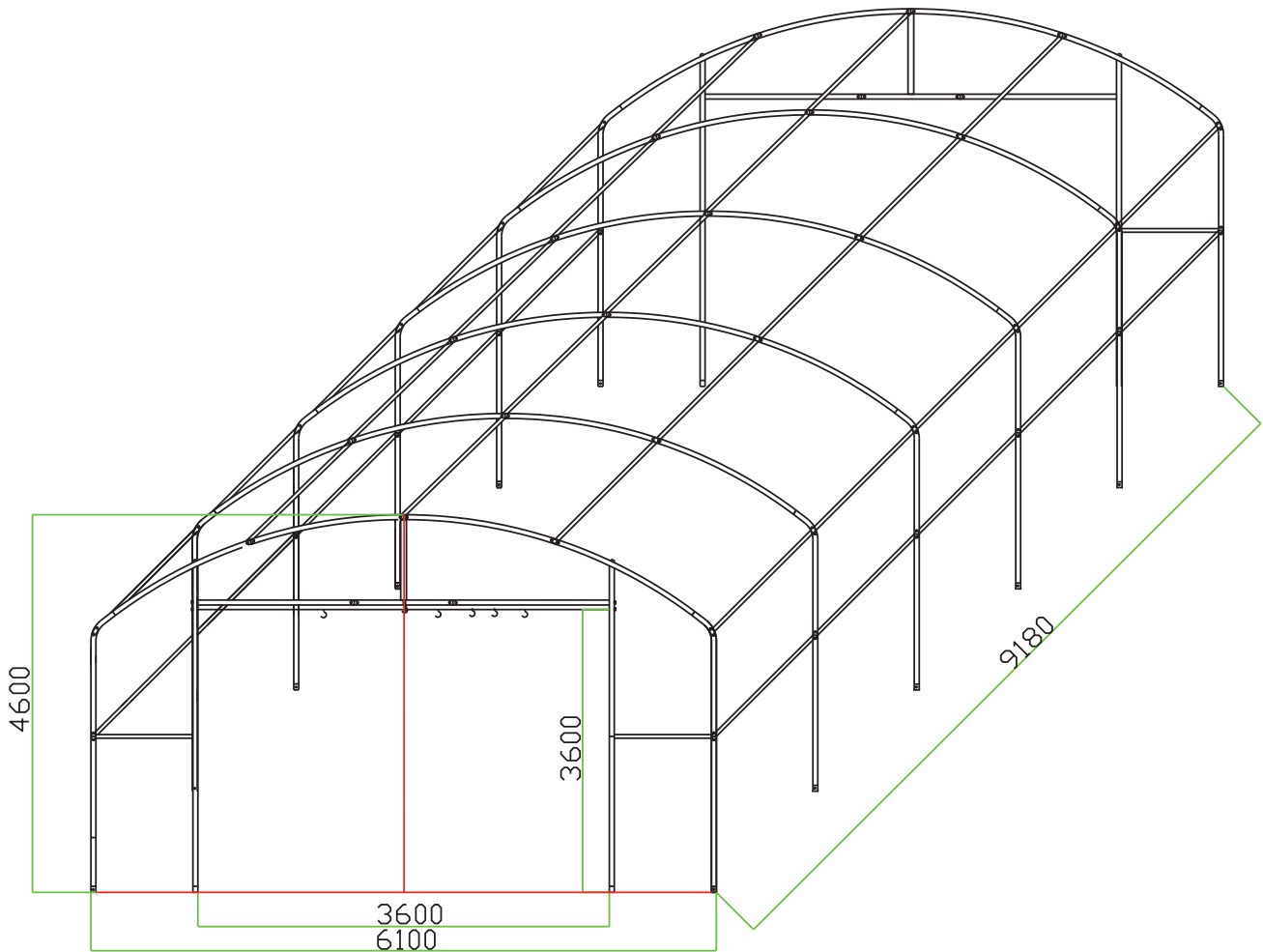

※サイズは約です。必ず現物で合わせてください。

Base drawing

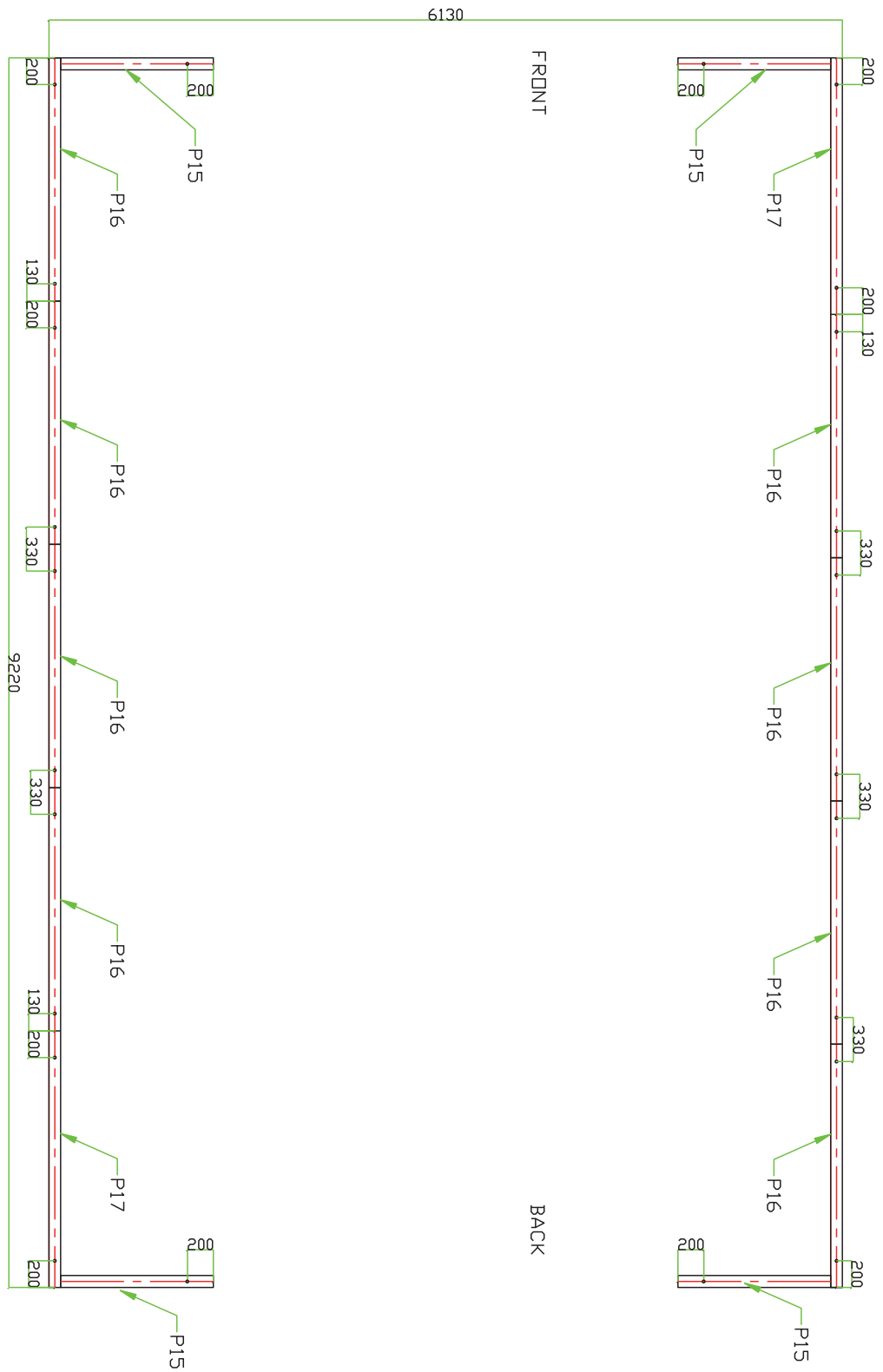

※サイズは約です。必ず現物で合わせてください。

Frame Assembly Steps

Step 1: Choose the place, Measure according to above drawing, Place and connect the base with #15,#16,#17 as illustrated below, fix to solid ground with #28,then install the ratchet on it.

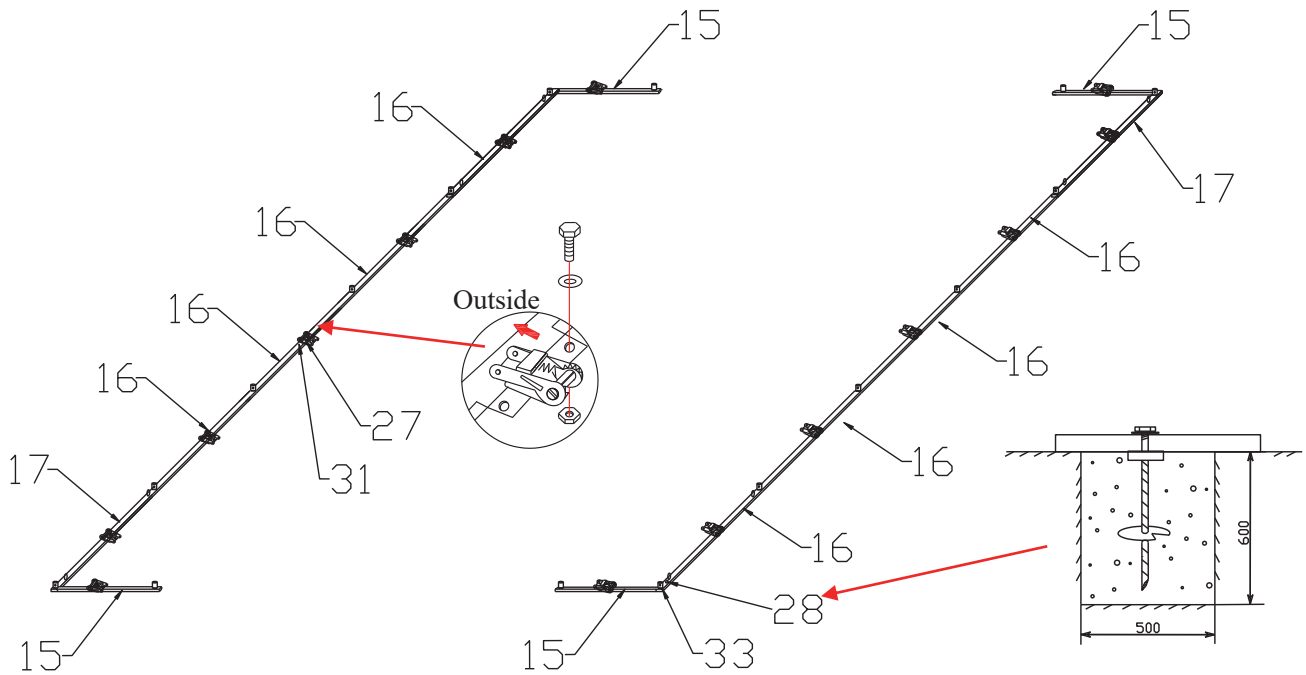

Step 2: Install the first row of rafters with #1,#2,and #3,#5,#6 ,then put it in the base feet.(To avoid accident, It is very important to hold the first row of rafter with support(wood, rope or similar thing), make sure that it won't fall down.)

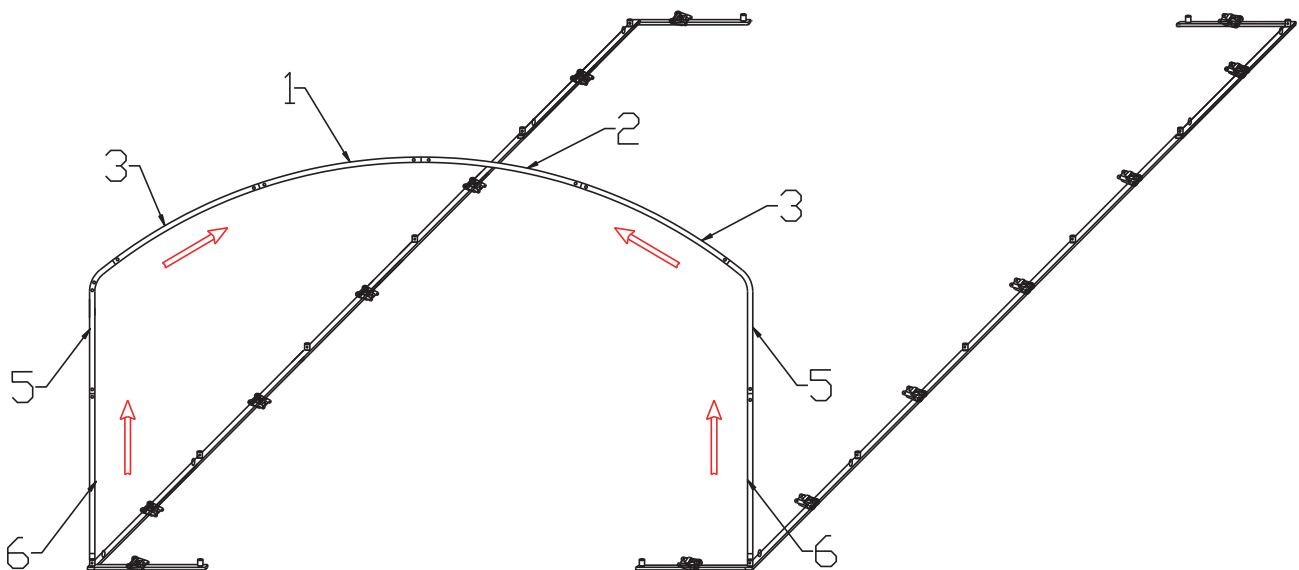

Covering Your World

Step 3: Install the second row of rafters with #1, #2 and #4, #6, Put it in the base feet, then connect to first row with #12, #13, brace with #24, #25 and fasten.

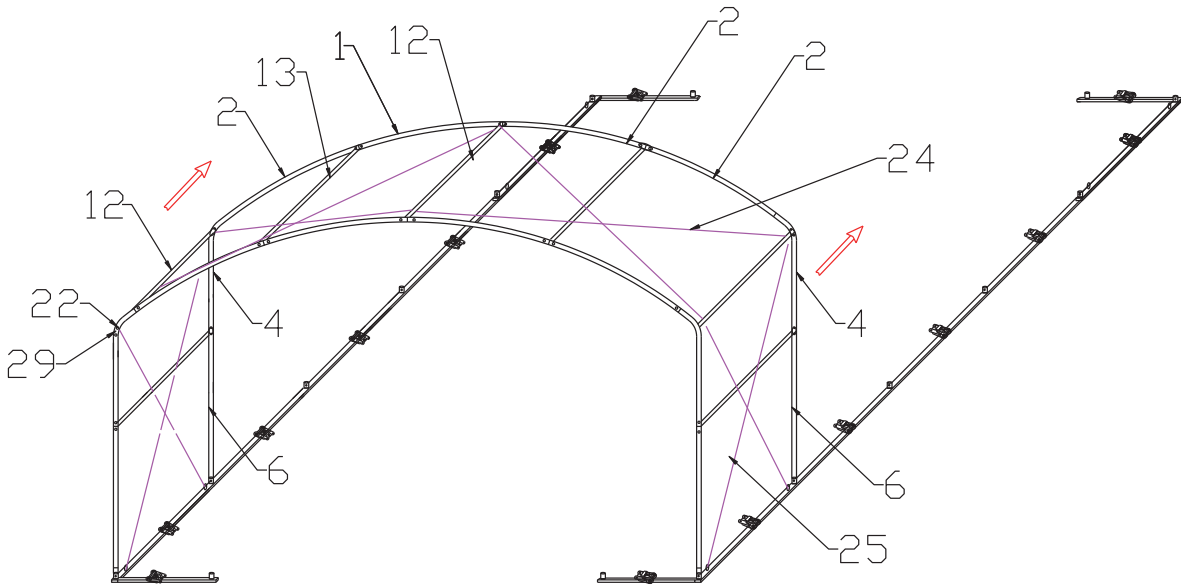

Step 4: The same way to install other rows of rafters.

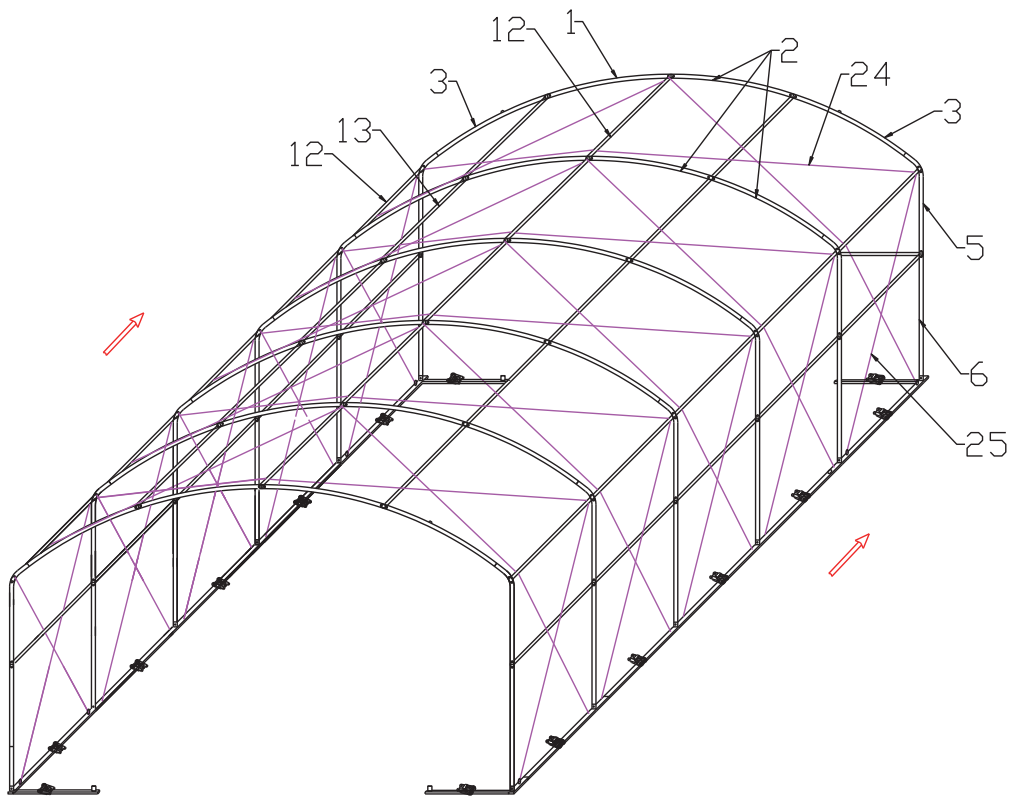

Covering Your World

Step 5: Install the door frames as shown below, and fasten all the screws and parts again.

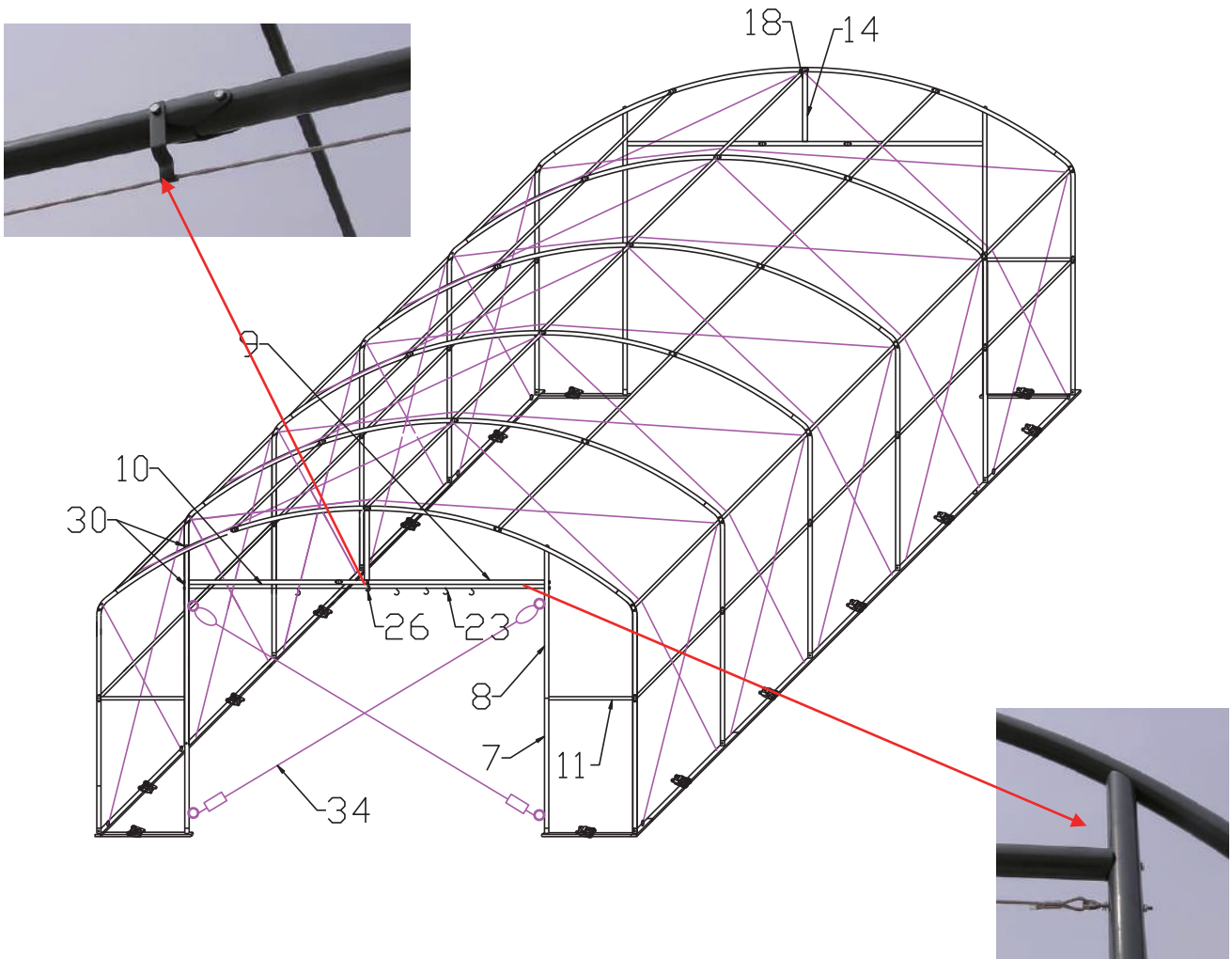

Tips: The tools below may be needed while installing the shelter.

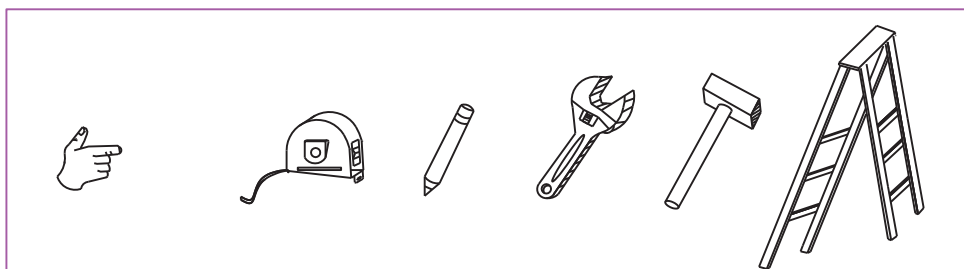

Cover Installation

TIPS : Slide the roof cover over assembled frame from one side

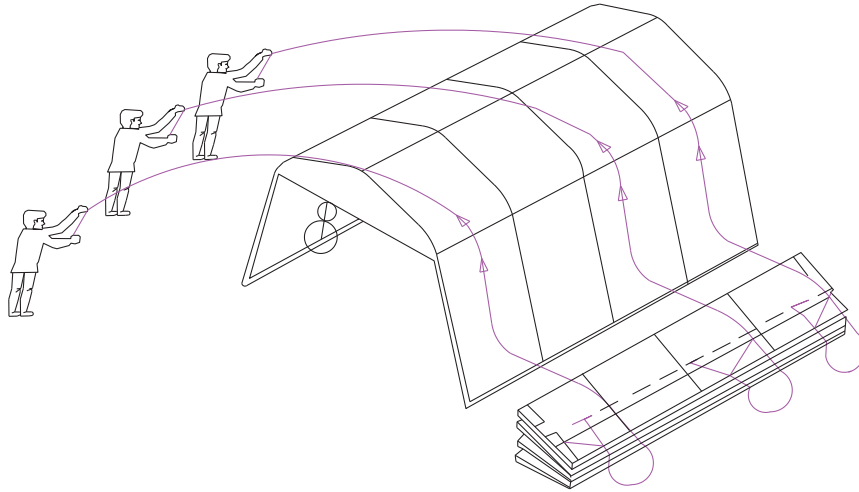

insert the conduit to pocket on side:

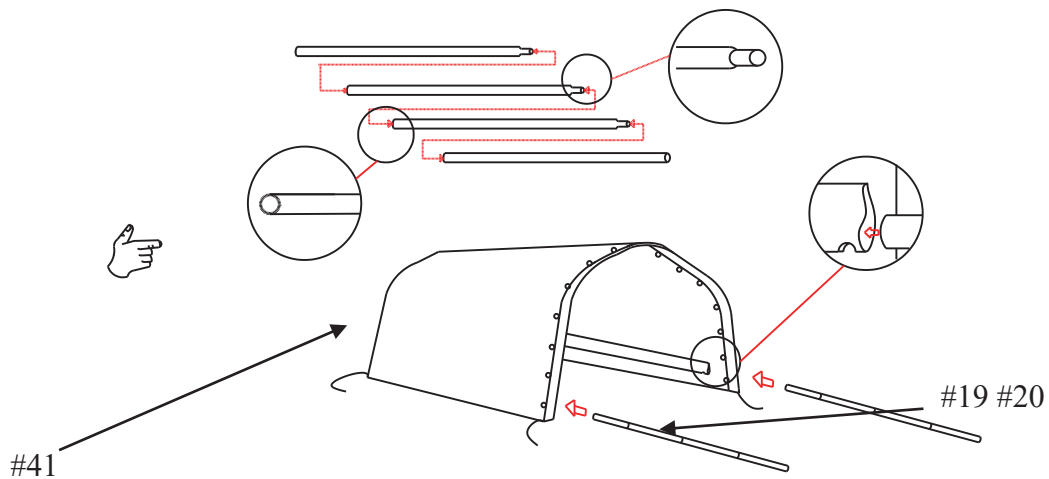

Pocket for side wall conduit
Ratchet tie down for tensioning the Side wall (roof cover)

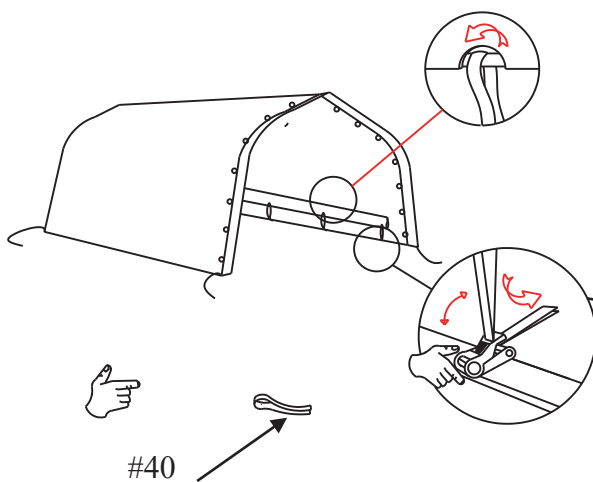

Covering Your World

Step 2 : Attach the cover (#35/#36) to the frame as following :

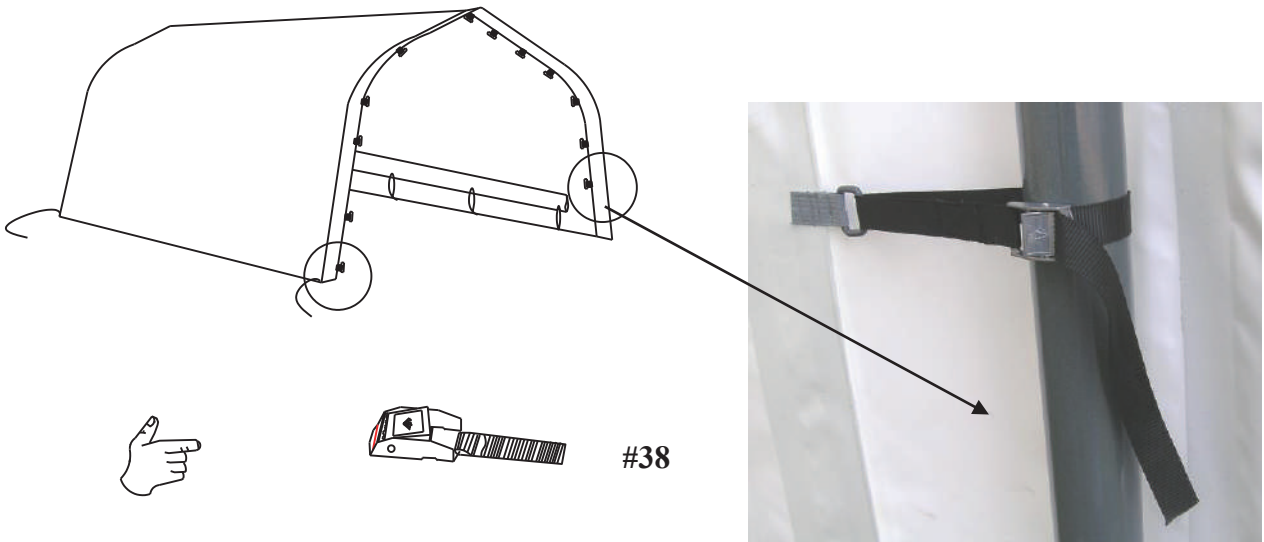

Note:#38for main roof cover tensioning.
#39 for front and end covers tensioning.

Your assembled shelter will be similar to the illustration as below :

Illustration for Ratchet

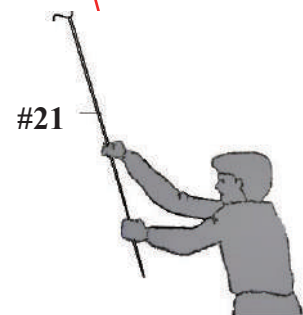
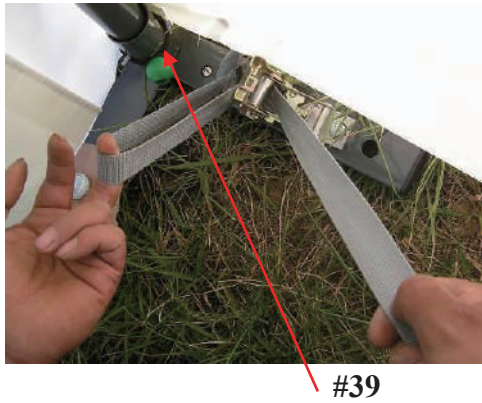

(in order to protect the shelter from heavy wind, please install the wind bracing straps at points 300 mm measuring from the ends, and others to be installed in the middle averagely.) (photos are for reference only, the real quantity is according to packing list.)

