

PORTABLE SHELTER INSTRUCTIONS

MODEL: SH-RO204015

L15.2 x W 6.1x H4.6m



PICTURE MAY NOT REFLECT THE EXACT MODEL

Covering Your World

TO OUR NEW AND VALUED CUSTOMER

Thank you for purchasing your new Instant Shelter. We know you will have as much pleasure owning your new shelter as we had in making it for you. Our shelters have been designed for rapid assembly and minimal maintenance. We have rigorous quality control at every step of the shelters manufacturing process to insure you the best unit money can buy. Our parts are triple checked prior to packaging to insure you will have everything you need before you start. In the unlikely event that a part is damaged or missing, you should immediately contact your place of purchase for a speedy replacement.

And Now a Few Words About *Safety*

HEAD PROTECTION IS RECOMMENDED!

Working with or under heavy parts included with this shelter can cause serious head injury.

WEAR GLOVES

You will be working with metal parts which may have SHARP edges

CHECK WITH YOUR LOCAL AUTHORITIES

Underground POWER CABLES or GAS LINES may result in injury while securing the shelter. It may also result in having to move the building. A cursory check with the local building authorities will help alleviate these concerns.

Covering Your World

CLIMBING EQUIPMENT

It is highly recommended that scaffolding, ladders and mechanical lifting equipment conform to all local building codes when erecting the shelter. Safety straps and harnesses should be used at all times. The metal structure of the shelter has not been designed for human weight. Erecting shelter during wind or rain is unsafe and could result in serious injury.

CHECK LOCAL WEATHER CONDITIONS

Check your local weather forecast prior to planning your building day. Wind, snow and/or rain may cause unsafe conditions that could lead to serious injury.

STORING HAZARDOUS MATERIALS

Check all local building codes prior to storing any hazardous material. Shelter may require additional ventilation to meet local codes.

SEVERE WEATHER CONDITIONS

Working in and around the portable shelter during severe weather is not recommended. Serious injury could result. In the event that extraordinarily severe wind, snow or other severe conditions are predicted and if time permits, it is recommended that the shelter cover be removed.

PREVENT ENTRAPMENT

Check Shelter for co workers before locking up. Always provide for escape in case of emergency.

Covering Your World

SHELTER RELOCATION

Should the shelter require relocation or disassembly for any reason, it is strongly recommended that the structure and its cover are thoroughly inspected prior to rebuilding

PERIODIC SHELTER INSPECTION

As with all structures, periodic inspection of the cover and all structural components is highly recommended. Tightening the cover and the structure will prolong the life of your investment









PLEASE BE Safety CONSCIOUS!

Common Sense is the knack of seeing things as they are, and doing things as they ought to be done. *Harriet Beecher Stowe*

UNPACKING & IDENTIFYING PARTS

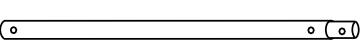
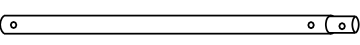
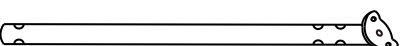
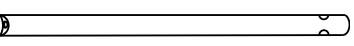
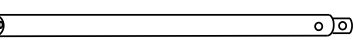
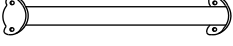
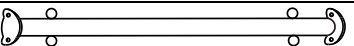
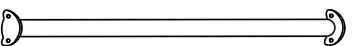
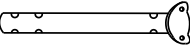
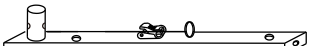







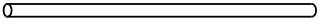
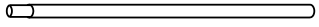
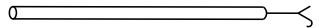

Prior to assembling your New Portable Shelter, unpack all crates and complete an inventory of all parts according to the following list and diagrams

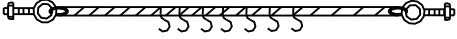
PARTS LIST FOR SH-RO205015

Parts#	Descriptions	Diagram	Dimensions (in mm)	Q'TY	BOX
1	Top roof arched rafter(left)		Φ 60x1600	9	1
2	Roof arched rafter		Φ60x1600	23	1
3	Lower Roof arched rafter (end)		Φ60x1600	4	1
4	Side upper curved rafter		Φ60x1450	14	1
5	Side upper curved rafter(end)		Φ60x1450	4	1
6	Side vertical rafter(leg)		Φ60x1800	18	3
7	Inside door vertical tube(lower)		Φ60x2000	4	3
8	Inside door vertical tube(upper)		Φ60x2035	4	3
9	Upper door cross tube		Φ60x1800	2	3
10	Upper door cross tube		Φ60x1800	2	3
11	Side door frame cross support tube		Φ45x1035	4	3
12	Top and side roof purlin		Φ45x1838	24	2
13	Purlin		Φ45x1838	32	2
14	Upper door vertical support		Φ60x770	2	3
15	Door frame base rail		90x30x1180	4	3
16	Side base rail(end)		90x30x1980	2	3
17	Side base rail		90x30x1888	14	3
18	Upper door vertical support connector			2	1

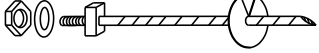
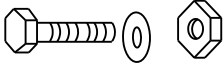
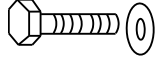
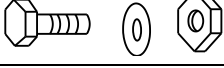
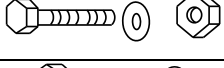
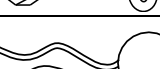
Covering Your World

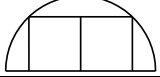
PARTS LIST FOR SH-RO205015

Parts#	Descriptions	Diagram	Dimensions (in mm)	Q'TY	BOX
19	Cover conduit		Φ25x1935	2	4
20	Cover conduit		Φ25x1935	14	4
21	Zipper tool(open/close)		Φ16x1800	1	4
22	Fixer (for door frame)			30	1
23	Door sliding cable (S:14pcs)		Φ6x3600	2	1
24	Roof bracing cable kit		Φ6x3630	32	1
25	Side wall bracing cable kit		Φ6x3260	32	1
26	Door sliding cable support hook			2	1
27	Ratchet tie-down			16	3
28	Anchor		M16x450	36	3
29	Screw, washer and nut		M8x80	192	1
30	Screw and washer for door frame and door base rail		M8x80	8	1
31	Screw, washer and nut for ratchet		M8x15	32	1
32	Screw, washer and nut		M8x120	14	1
33	Screws for door base		M8x120	4	1
34	Ball type bungee		Φ5x570	68	1
			Φ5x380	72	1
35	Strap band(for ratchet)		25x700	16	1
36	End and door cover			2	4
37	Main cover			1	4
38	Wrench		#12-14	2	1

Covering Your World

L15.2 x W 6.1x H4.6m SH-RO205015

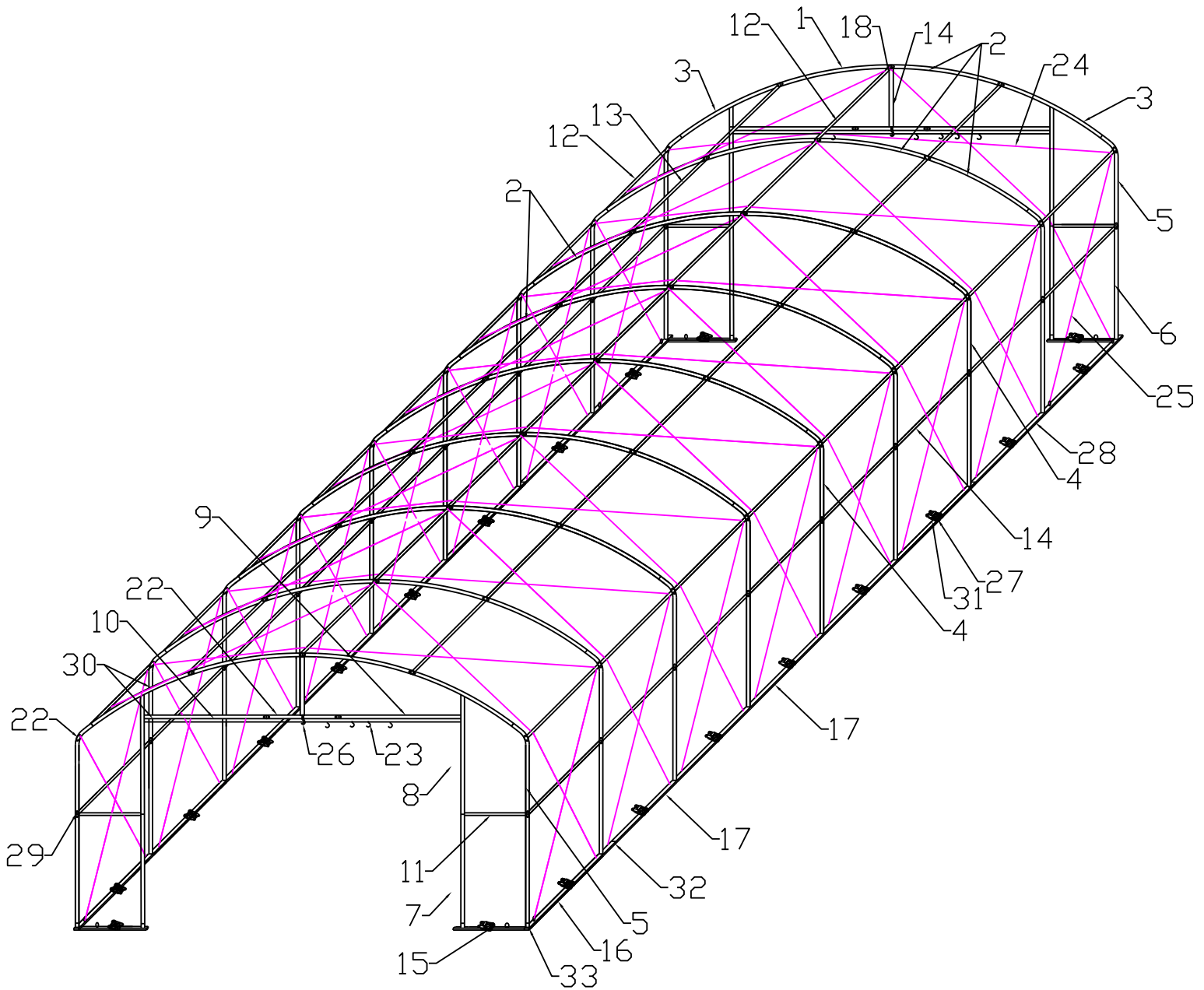

SH-RO205015 Main Dimension (mm)

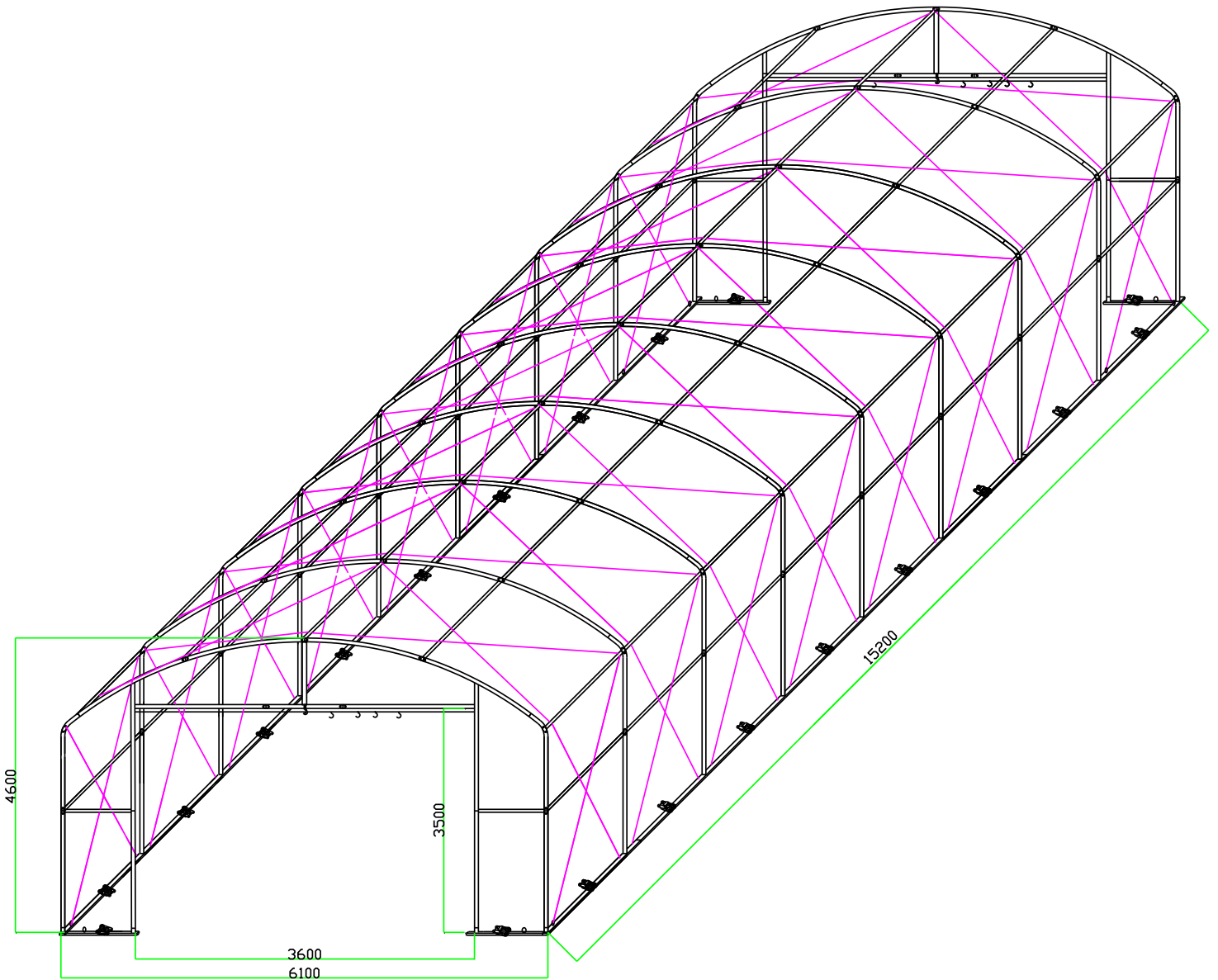

Frame Assembly Steps

Step A : Assemble roof rafter#1,#2 and #3, then connect with purlin#12 and #13

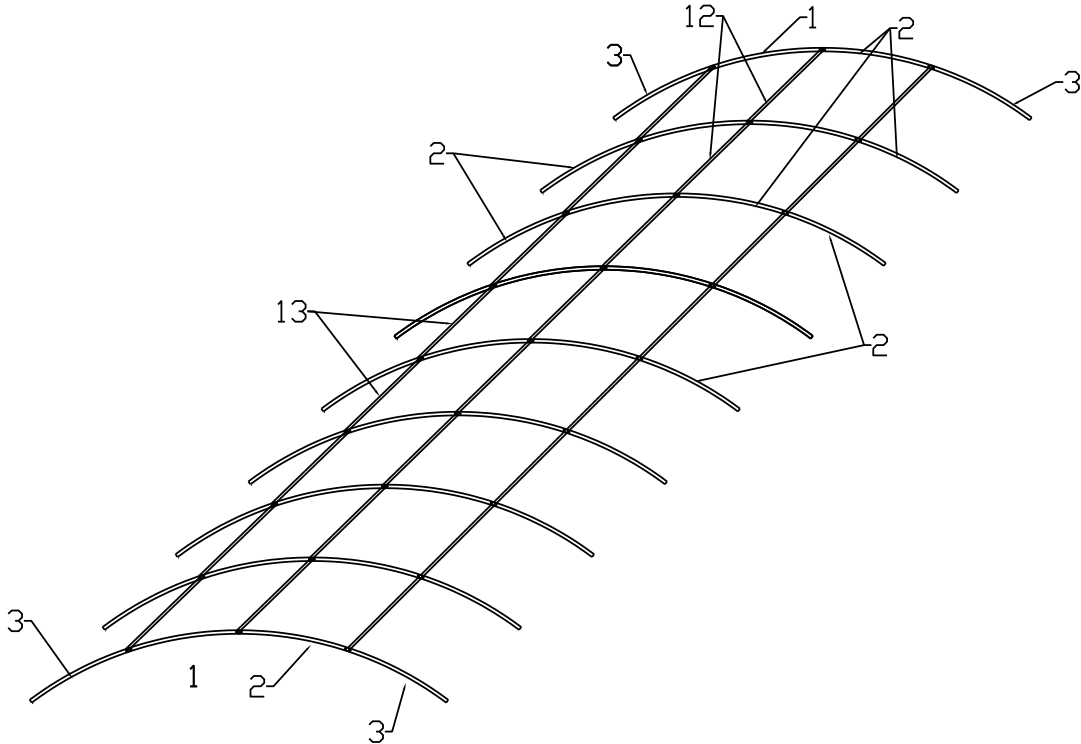

Step B: Install side curved rafter#4, #5 and purlin #12, then brace the roof with cables.

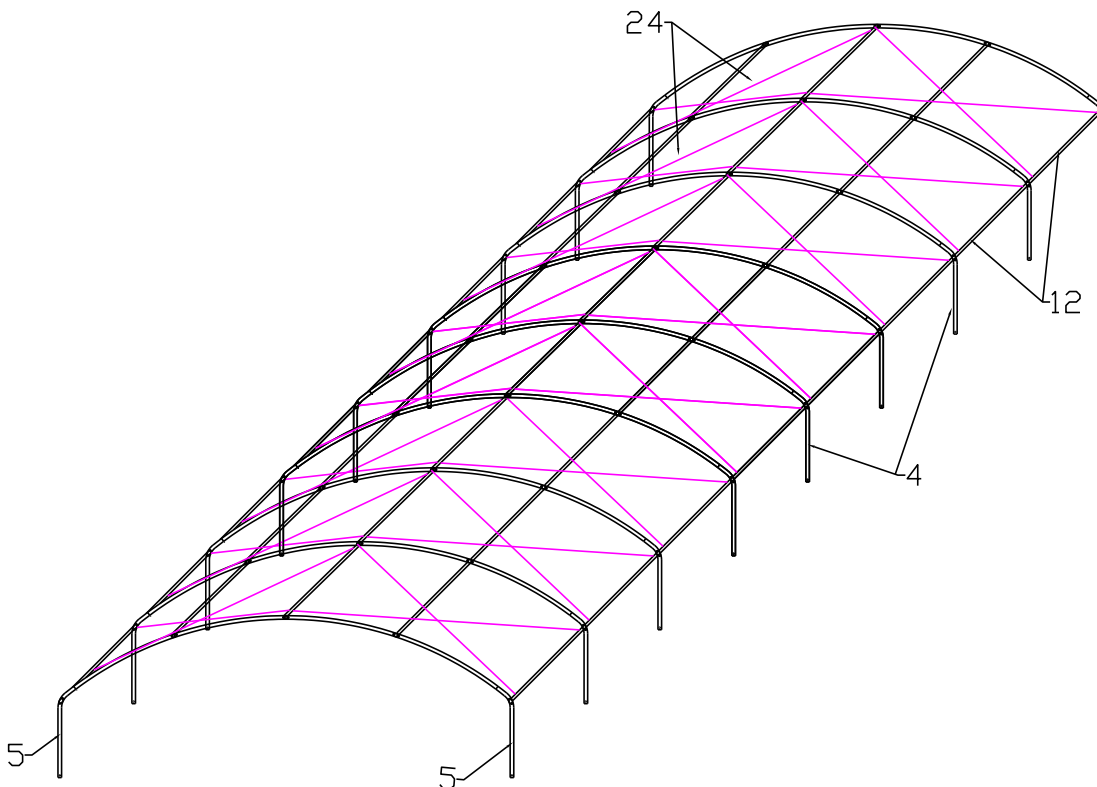

Notice: Apply heavy duct tape on all pipe connections and clamps that may contact the cover. (tape are not included in the packaging, please buy it on market)

Covering Your World

Step C : Install side vertical rafters #6 and connect with purlin.

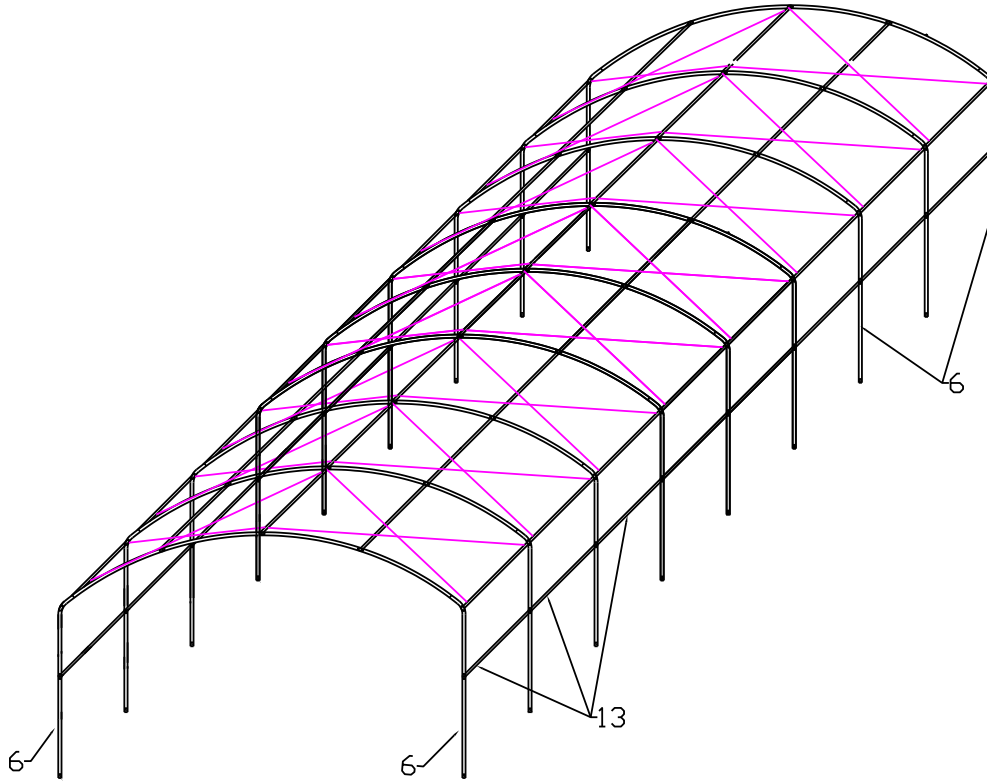

Step D: Put the base rails #15, #16, #17 in position, put the above frame into base feet. Then install the door frame as shown below.(fasten each part by screws)

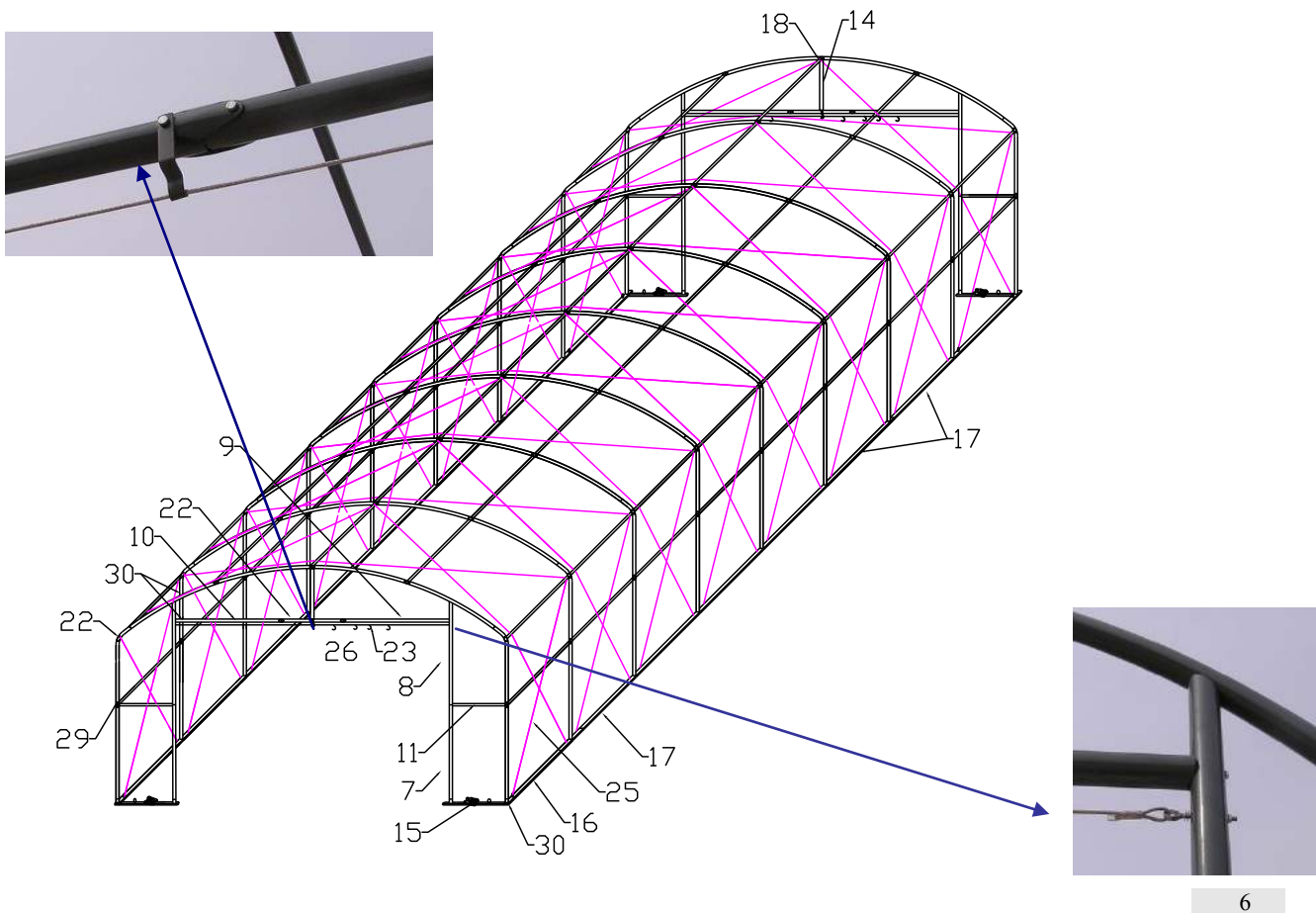

Covering Your World

Step E : Install ratchet #27 on base rails with screws#31, fix the base rail on solid ground with anchor#28.

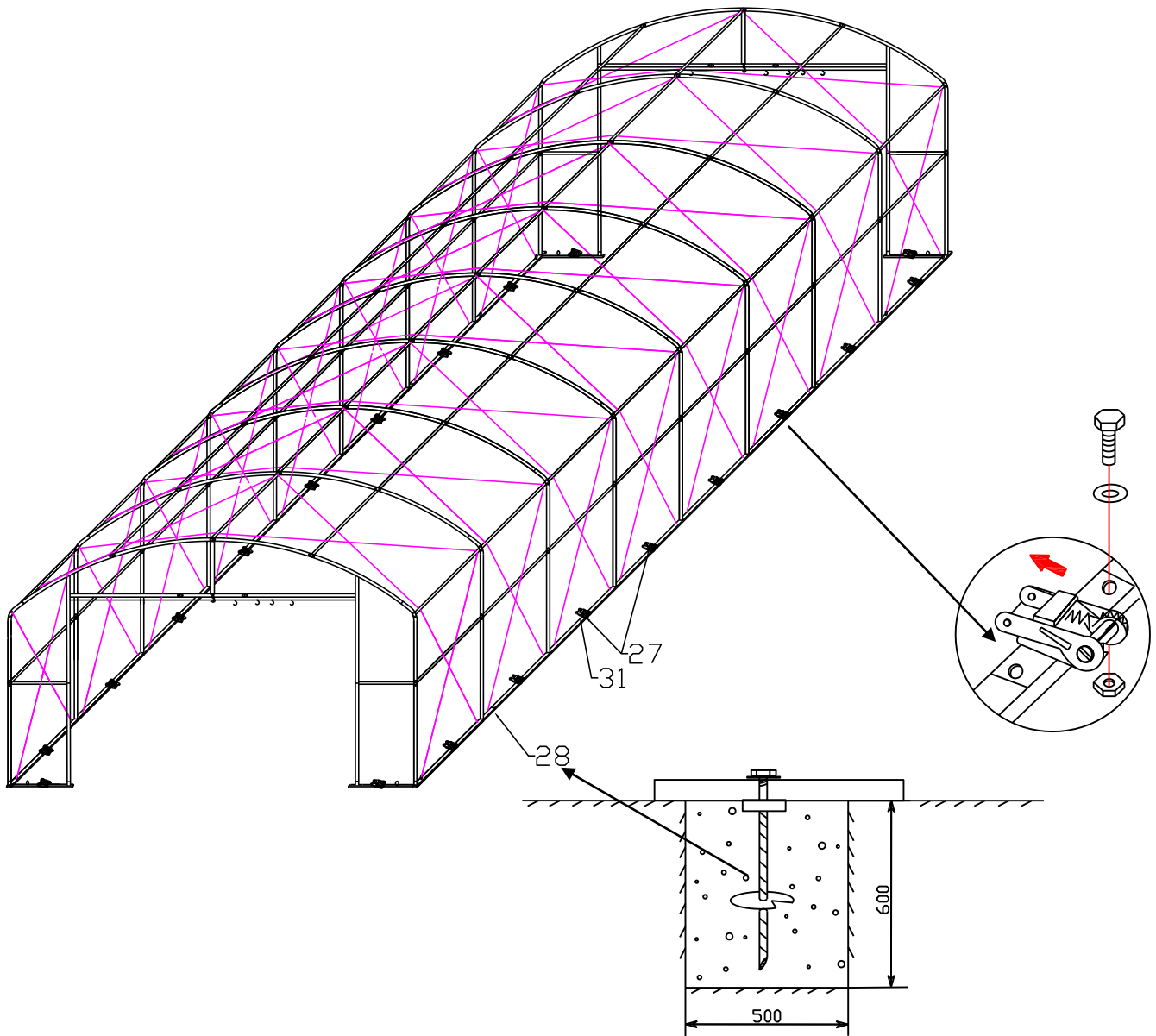

Tips: The tools below may needed while installing the shelter.

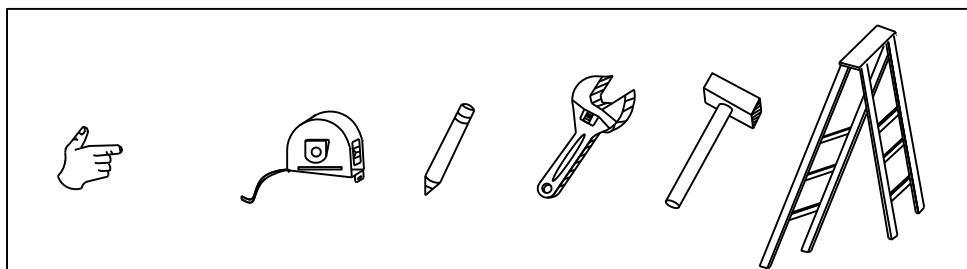

Roof Cover Assembly

TIPS : Slide the roof cover over assembled frame from one side and insert the conduit to pocket:

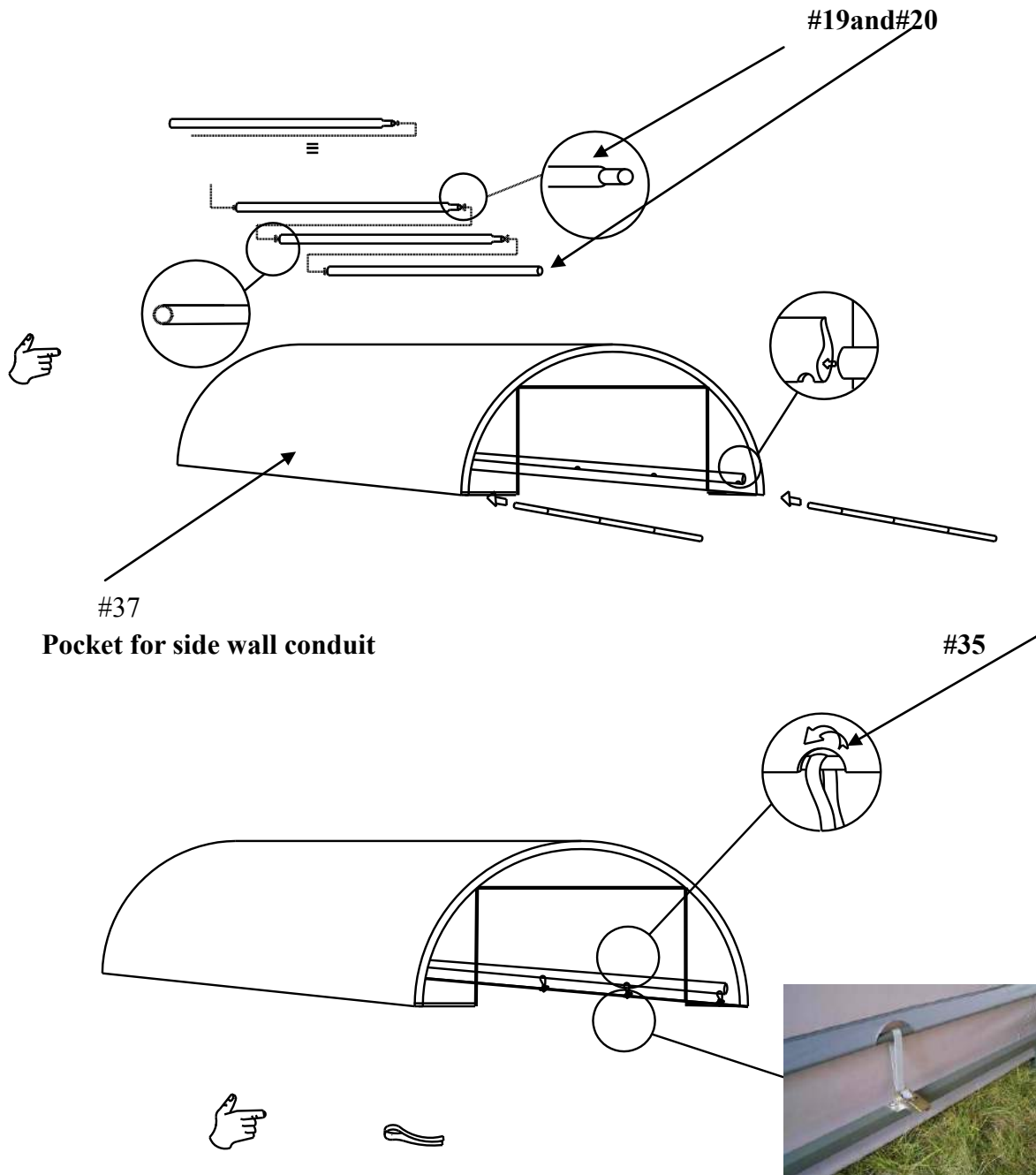

Ratchet Tie-Down for Tensioning the side wall (roof cover)

Covering Your World

TIPS : Secure the ends to frame with bungee and Velcro and attach the door cover to the doorframe as following :

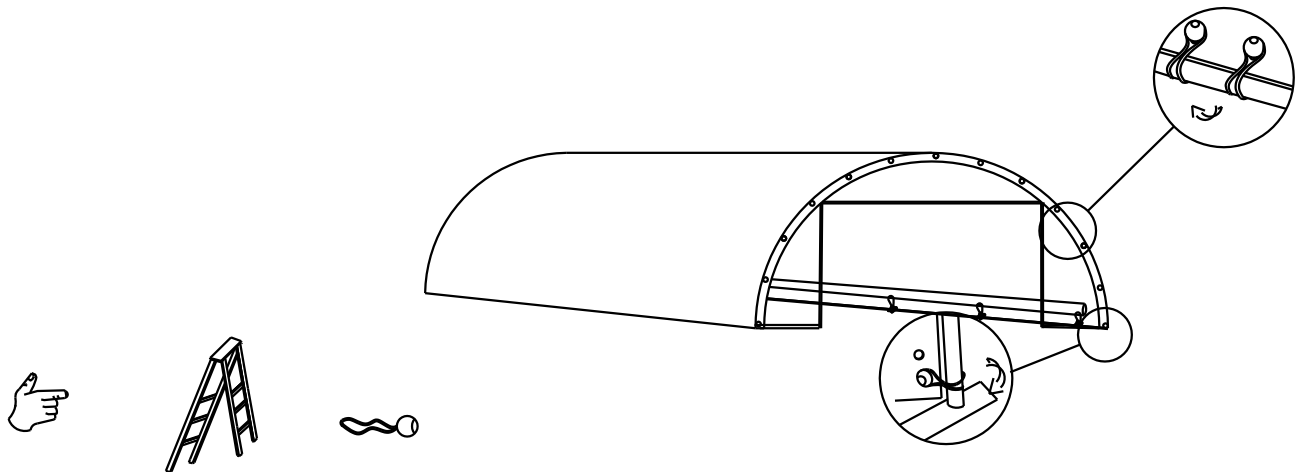

#34

Attach door cover to frame with bungee.

#36

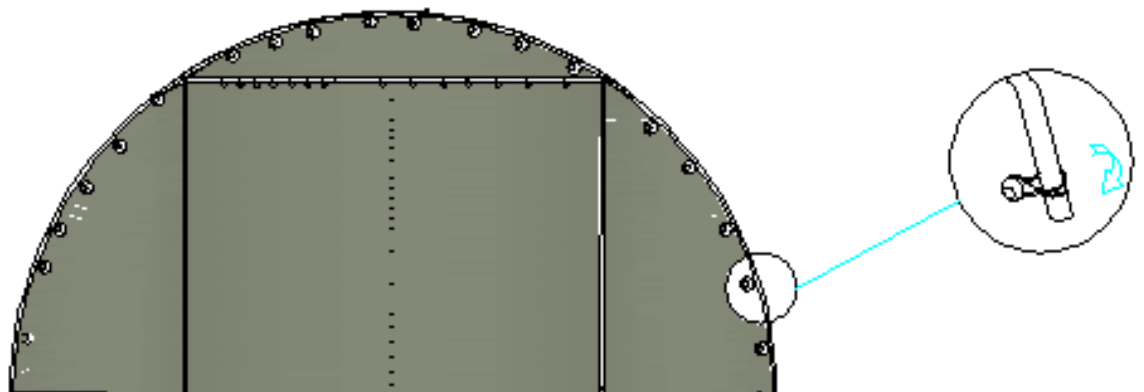

Covering Your World

Attach door cover to frame with Ball Bungee and velcro.



Insert the strap(sewed on cover) through the ring and into the ratchet and tie.

