

FABRIC BUILDING INSTRUCTIONS

MODEL:SH-RO254015

W7.6xL12.2xH4.6(m)



PICTURE MAY NOT REFLECT THE EXACT MODEL

Covering Your World

TO OUR NEW AND VALUED CUSTOMER

Thank you for purchasing your new Instant Shelter . We know you will have as much pleasure owning your new shelter as we had in making it for you. Our shelters have been designed for rapid assembly and minimal maintenance. We have rigorous quality control at every step of the shelters manufacturing process to insure you the best unit money can buy. Our parts are triple checked prior to packaging to insure you will have everything you need before you start. In the unlikely event that a part is damaged or missing, you should immediately contact your place of purchase for a speedy replacement.

And Now a Few Words About Safety

HEAD PROTECTION IS RECOMMENDED!

Working with or under heavy parts included with this shelter can cause serious head injury.

WEAR GLOVES

You will be working with metal parts which may have SHARP edges

CHECK WITH YOUR LOCAL AUTHORITIES

Underground POWER CABLES or GAS LINES may result in injury while securing the shelter. It may also result in having to move the building. A cursory check with the local building authorities will help alleviate these concerns.

Covering Your World

CLIMBING EQUIPMENT

It is highly recommended that scaffolding, ladders and mechanical lifting equipment conform to all local building codes when erecting the shelter. Safety straps and harnesses should be used at all times. The metal structure of the shelter has not been designed for human weight. Erecting shelter during wind or rain is unsafe and could result in serious injury.

CHECK LOCAL WEATHER CONDITIONS

Check your local weather forecast prior to planning your building day. Wind, snow and/or rain may cause unsafe conditions that could lead to serious injury.

STORING HAZARDOUS MATERIALS

Check all local building codes prior to storing any hazardous material. Shelter may require additional ventilation to meet local codes.

SEVERE WEATHER CONDITIONS

Working in and around the portable shelter during severe weather is not recommended. Serious injury could result. In the event that extraordinarily severe wind, snow or other severe conditions are predicted and if time permits, it is recommended that the shelter cover be removed.

PREVENT ENTRAPMENT

Check Shelter for co workers before locking up. Always provide for escape in case of emergency.

Covering Your World

SHELTER RELOCATION

Should the shelter require relocation or disassembly for any reason, it is strongly recommended that the structure and its cover are thoroughly inspected prior to rebuilding

PERIODIC SHELTER INSPECTION

As with all structures, periodic inspection of the cover and all structural components is highly recommended. Tightening the cover and the structure will prolong the life of your investment

PLEASE BE Safety CONSCIOUS!









Common Sense is the knack of seeing things as they are, and doing things as they ought to be done. Harriet Beecher Stowe

THANK YOU FOR CHOOSING A SHELTER

UNPACKING & IDENTIFYING PARTS

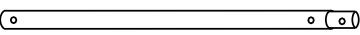
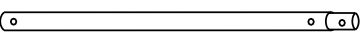
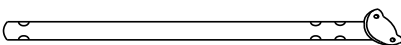
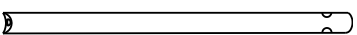
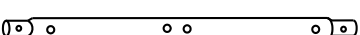
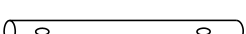
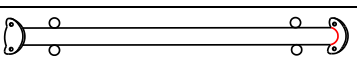
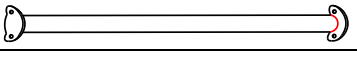
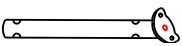

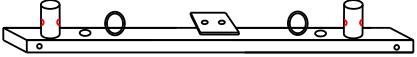
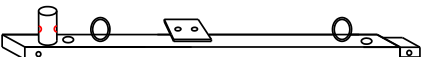



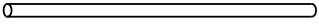
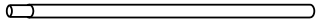
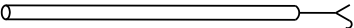

Prior to assembling your New Portable Shelter, unpack all crates and complete an inventory of all parts according to the following list and diagrams

PARTS LIST FOR SH-RO254015

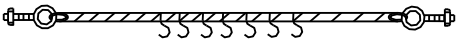
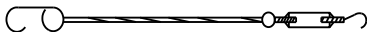
Parts#	Descriptions	Diagram	Dimensions (in mm)	Q'TY	BOX
1	Top roof arched rafter(left)		Φ60x1890	8	1
2	Roof arched rafter		Φ60x1890	20	1
3	Roof arched rafter(end)		Φ60x1890	4	1
4	Side roof curved rafter		Φ60x1601	16	1
5	Side vertical rafter(leg)		Φ60x1900	16	4
6	Inside door vertical tube(lower)		Φ60x1900	4	4
7	Inside door vertical tube(upper)		Φ60x2078	4	4
8	Upper door cross tube(left/right)		Φ60x1900	4	4
9	Upper door cross tube(mid)		Φ60x1200	2	4
10	Side door frame cross support tube		Φ45x1120	4	4
11	Top roof purlin		Φ45x1680	21	2
12	Purlin		Φ45x1680	28	2
13	Upper door vertical support		Φ60x975	2	
14	Door frame base rail		70x25x1253	4	3
15	Side base rail(end)		70x25x1834	2	3
16	Side base rail		70x25x1736	12	3
17	Upper door vertical support connector				
18	Door sliding cable support hook			2	3

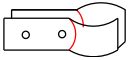
Covering Your World

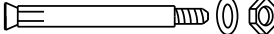
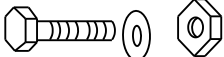
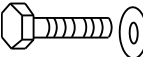
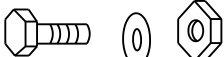
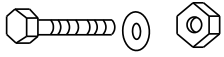
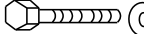
PARTS LIST FOR SH-RO254015

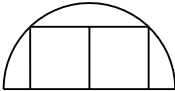
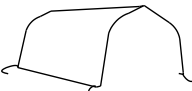
Parts#	Descriptions	Diagram	Dimensions (in mm)	Q'TY	BOX
19	Cover conduit		Φ25x1760	2	4
20	Cover conduit		Φ25x1760	12	4
21	Zipper tool(open/close)		Φ16x2000	1	4
22	Fixer (for door frame)			28	3
23	Door sliding cable (S:18pcs)		Φ6x5000	2	4
24	Roof bracing cable kit		Φ4x4160	28	4
25	Side wall bracing cable kit		Φ4x3380	28	4
26	Single way clamp			8	3
27	Ratchet tie-down			14	3
28	Wedge anchor		M12x150	32	3
29	Screw, washer and nut		M8x80	186	3
30	Screw and washer for door frame and door base rail		M8x80	8	3
31	Screw, washer and nut for ratchet		M8x15	28	3
32	Screw, washer and nut		M8x100		
33	Screws for door base		M8x100		
34	Ball type bungee		Φ5x570	76	4
			Φ5x380	80	4
35	Strap band(for ratchet)		25x700	14	4
36	End and door cover		7560x4600	2	4
37	Main cover		15250x12660	1	4

Covering Your World

L12.2 x W 7.6x H4.6m SH-RO254015

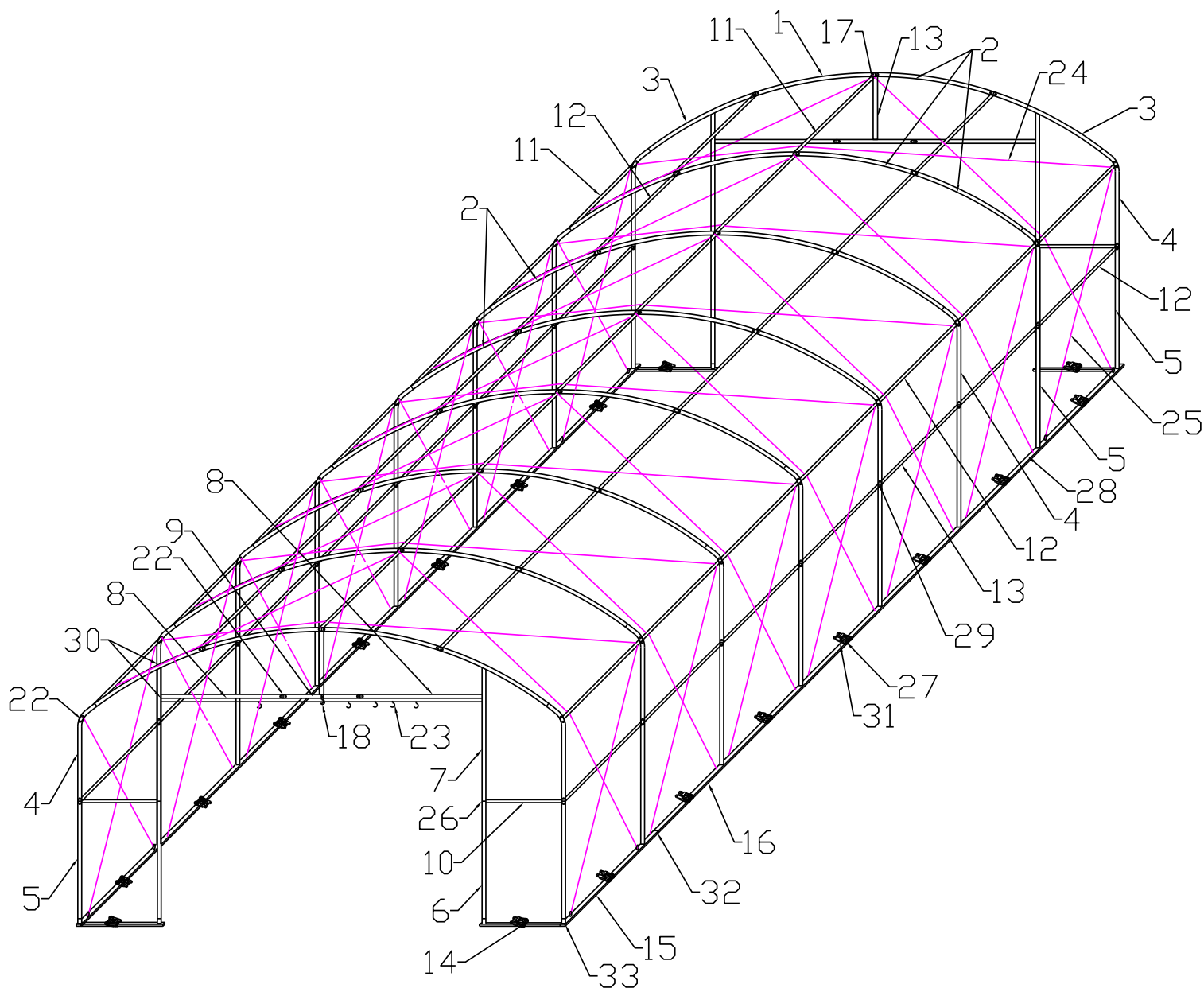

SH-RO254015 Main Dimension (mm)

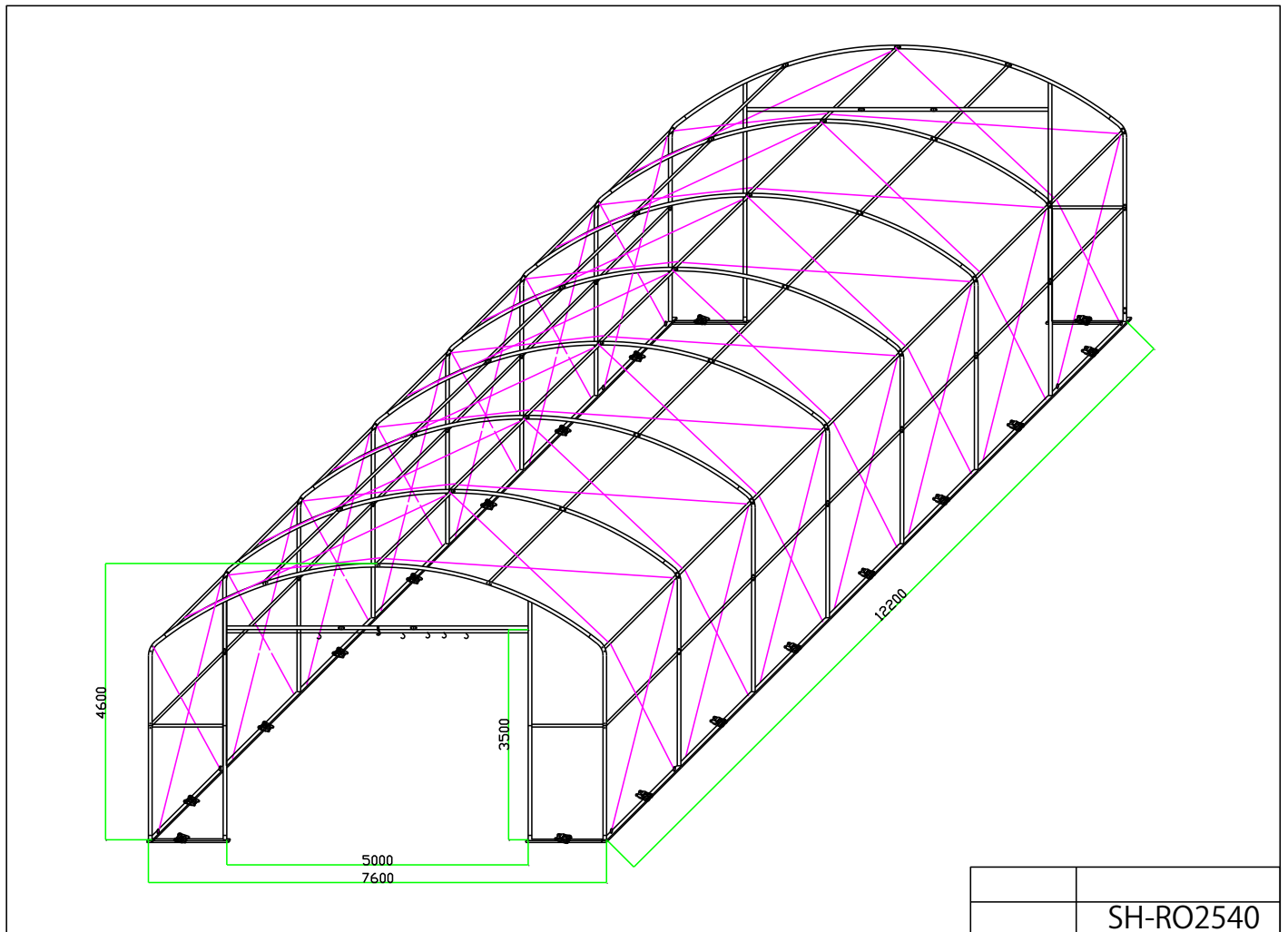

Frame Assembly Steps

Step A : Assemble roof rafter#1,#2 and #3, then connect with purlin#11 and #12

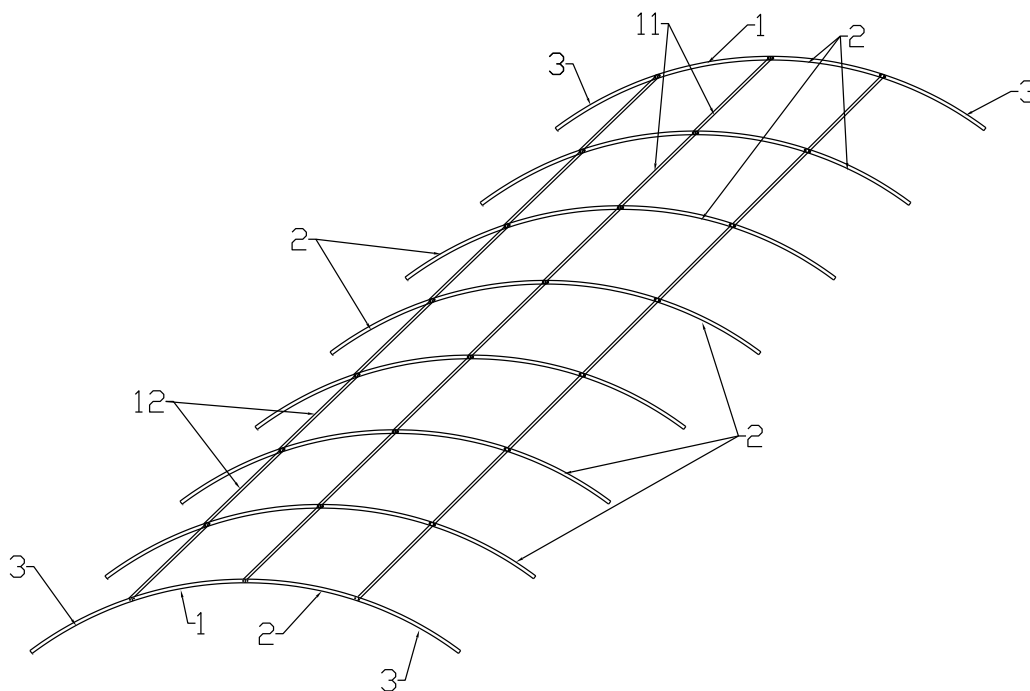

Step B: Install side roof rafter#4 and purlin #11, then brace the roof with cables.

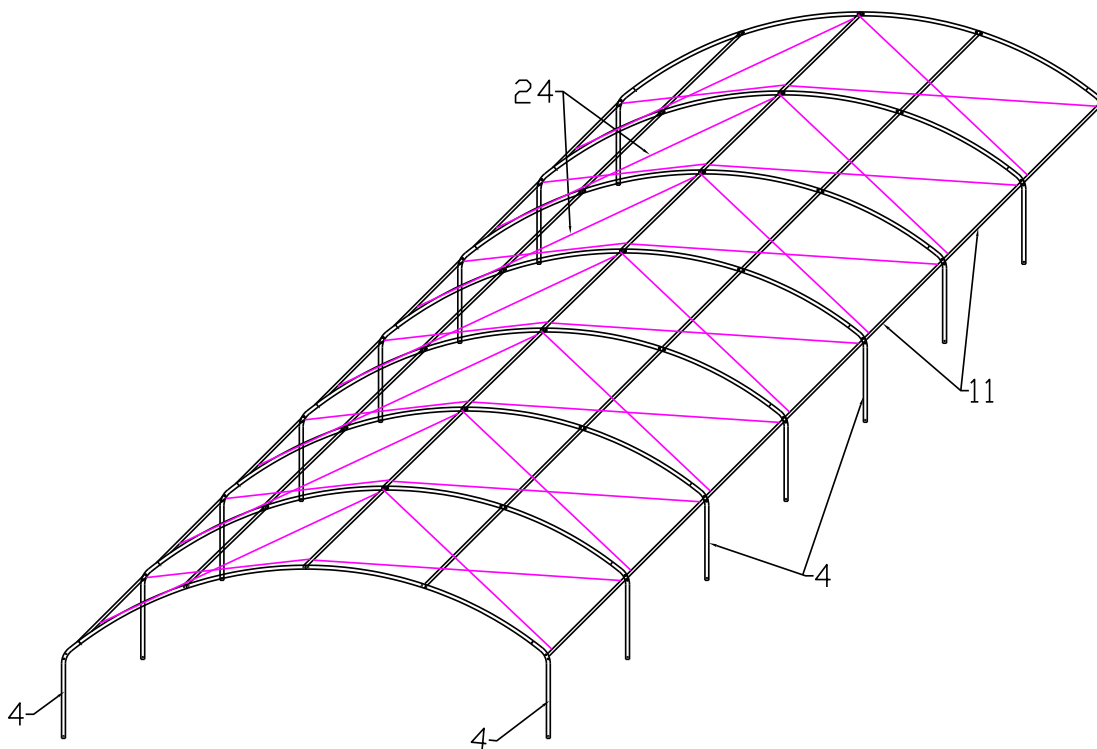

Notice: Apply heavy duct tape on all pipe connections and clamps that may contact the cover. (tape are not included in the packaging, please buy it on market)

Covering Your World

Step C : Install side vertical rafters #5 and connect with purlin.

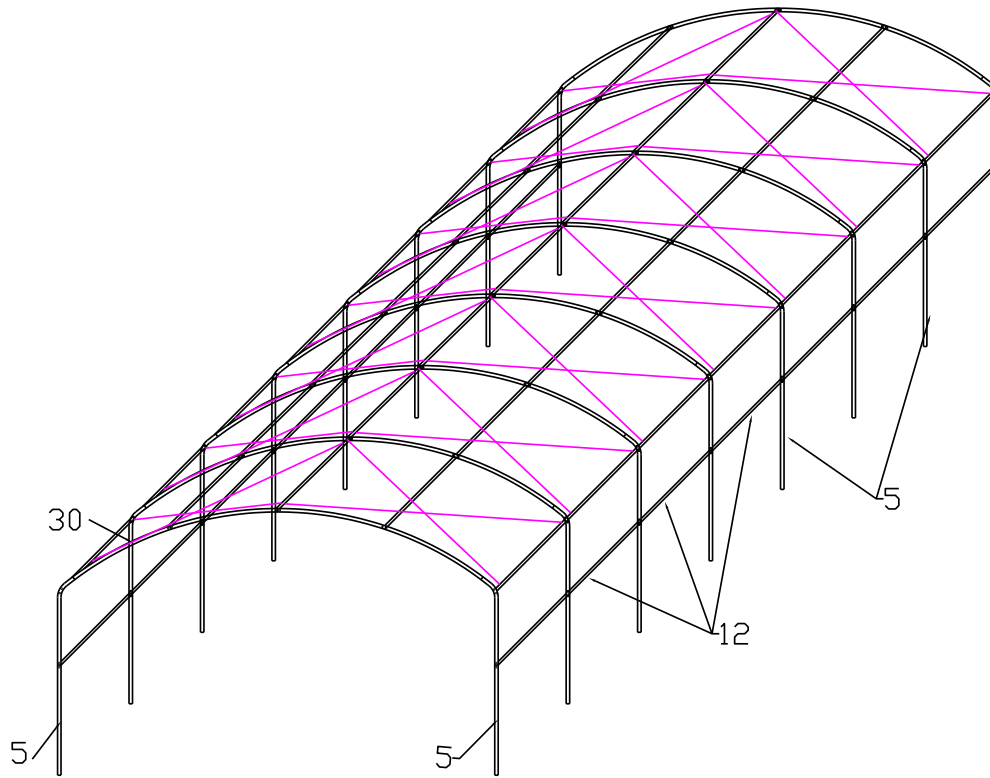

Step D: Put the base rails #14, #15, #16 in position, put the above frame into base feet. Then install the door frame as shown below.(fasten each part by screws)

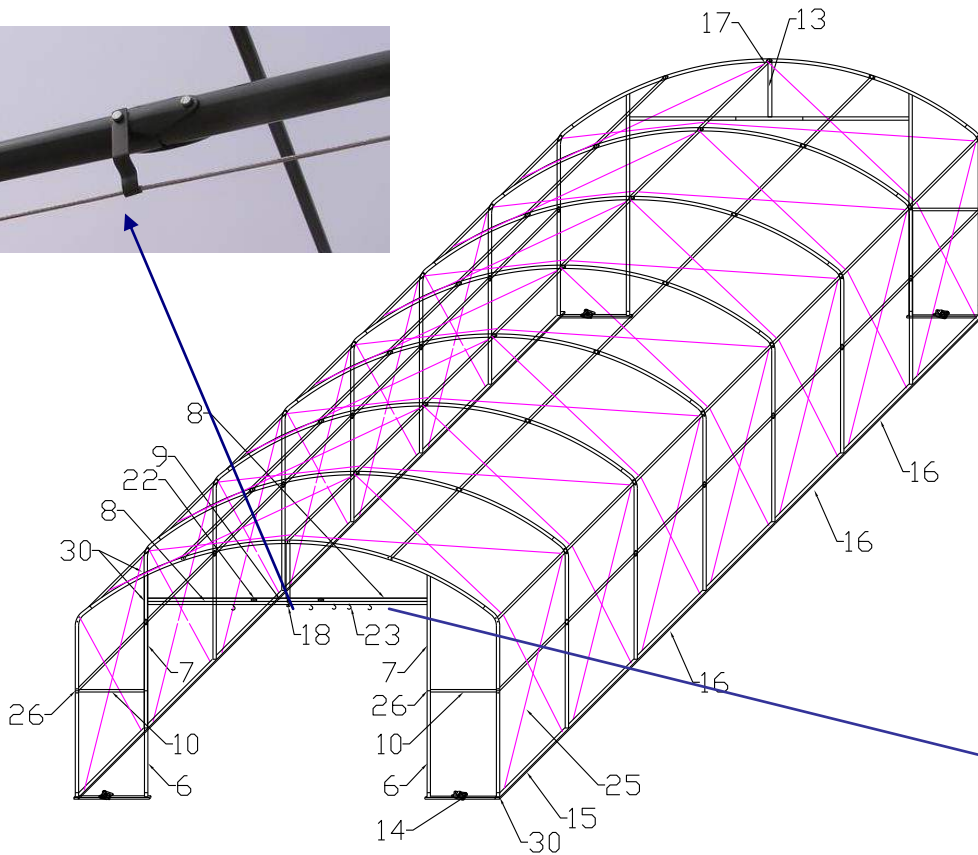
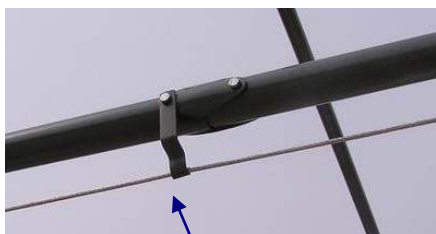

Covering Your World

Step E : Install ratchet #27 on base rails with screws#31, fix the base rail on solid ground with anchor#28.

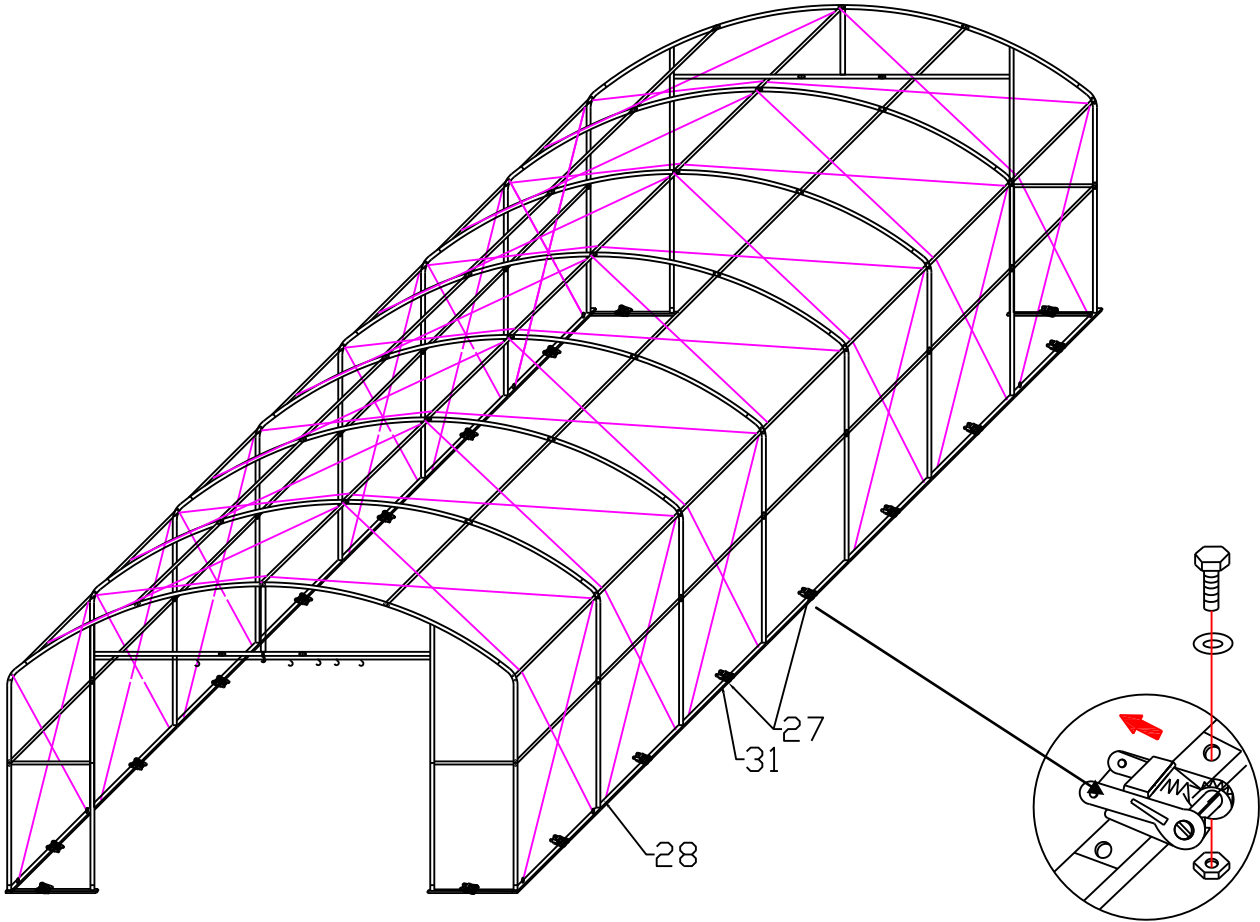

Tips: The tools below may needed while installing the shelter.

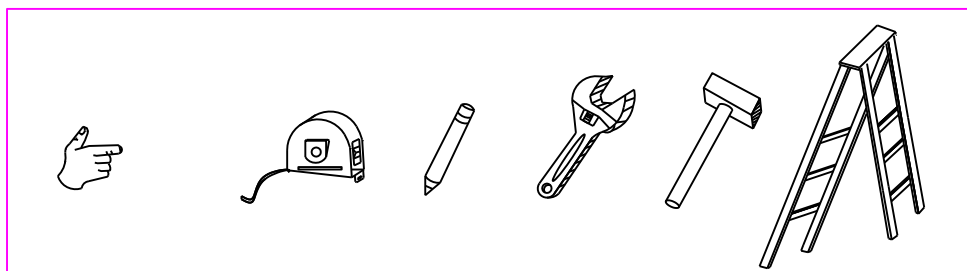

Roof Cover Assembly

TIPS : Slide the roof cover over assembled frame from one side and insert the conduit to pocket:

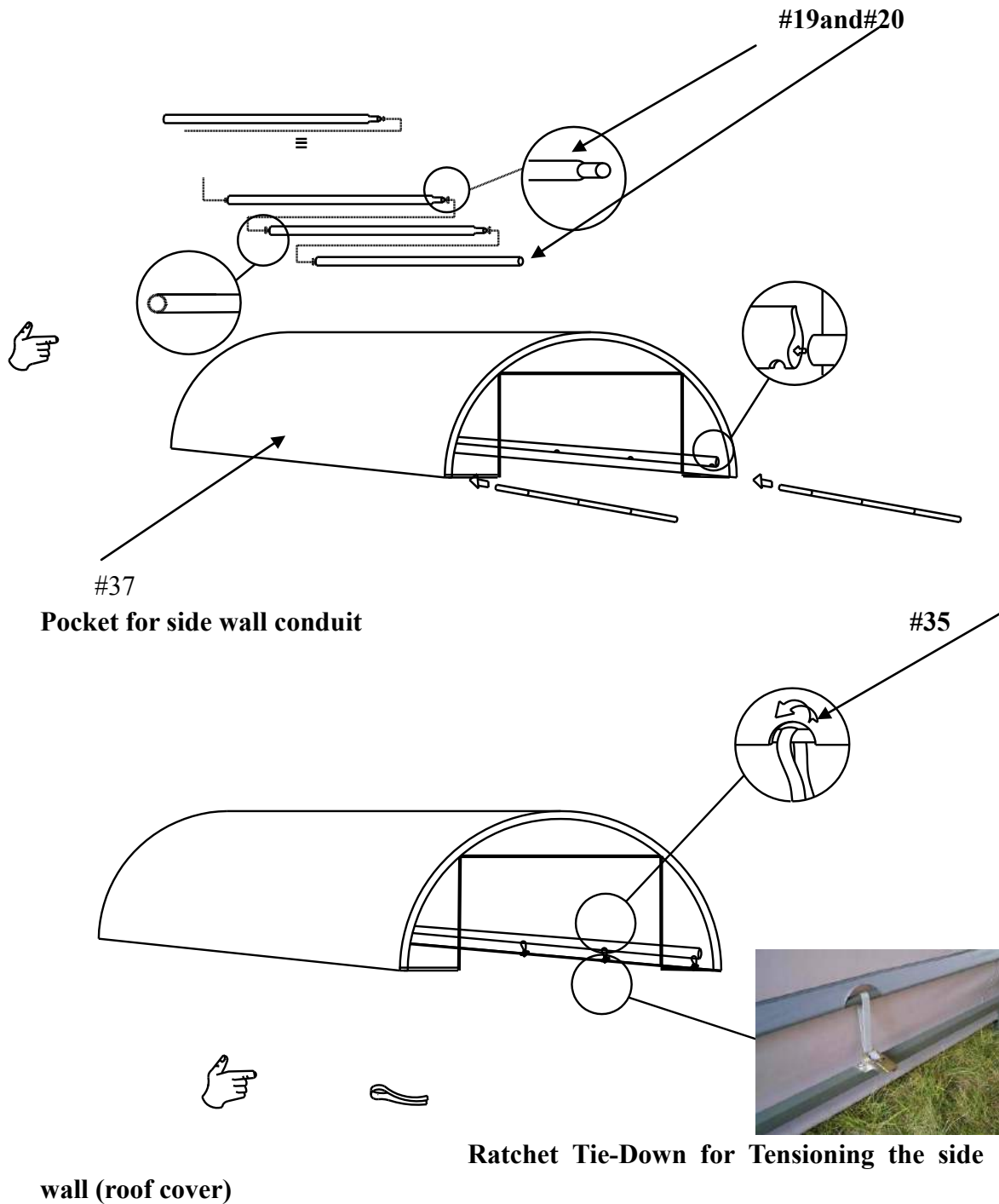

Covering Your World

TIPS : Secure the ends to frame with bungee and Velcro and attach the door cover to the doorframe as following :

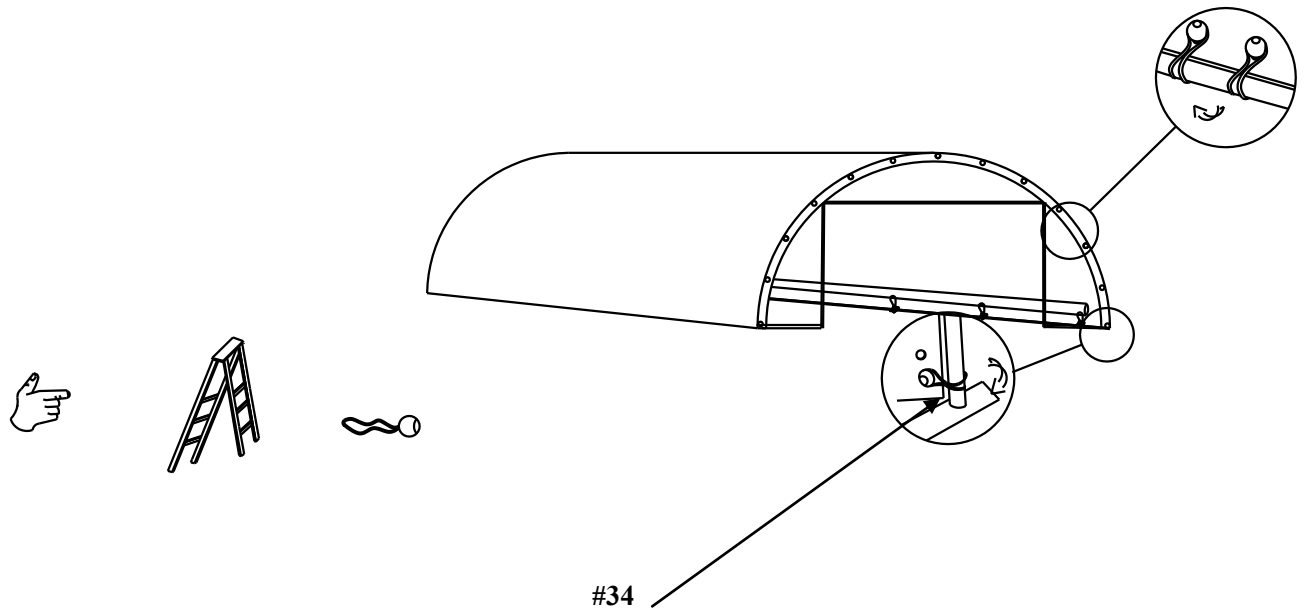

Attach door cover to frame with bungee.

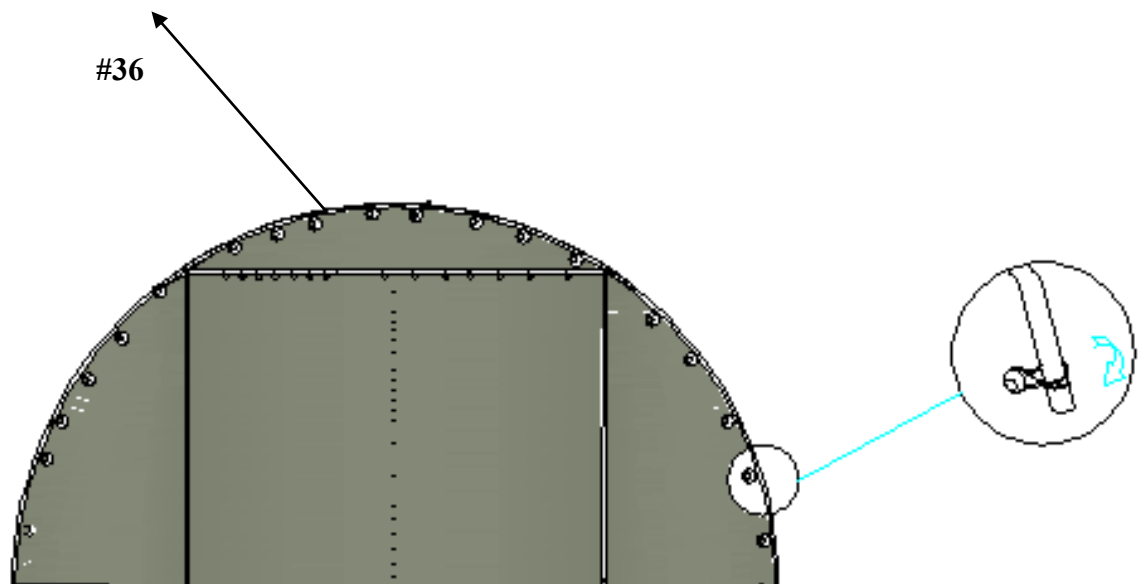

Covering Your World

Attach door cover to frame with Ball Bungee and velcro.

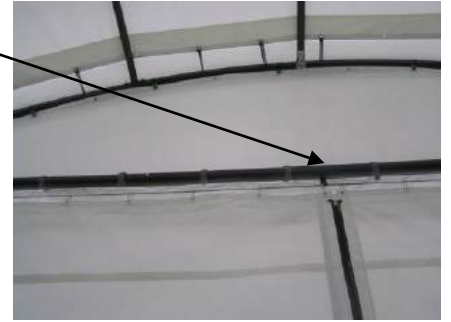

Insert the strap(sewed on cover) through the ring and into the ratchet and tie.