

Covering Your World

FABRIC BUILDING INSTRUCTIONS

MODEL: SH-RO44

L4 x W4 x H 3.55



PICTURE MAY NOT REFLECT THE EXACT MODEL

TO OUR NEW AND VALUED CUSTOMER

Thank you for purchasing your new Instant Shelter. We know you will have as much pleasure owning your new shelter as we had in making it for you. Our shelters have been designed for rapid assembly and minimal maintenance. We have rigorous quality control at every step of the shelters manufacturing process to insure you the best unit money can buy. Our parts are triple checked prior to packaging to insure you will have everything you need before you start. In the unlikely event that a part is damaged or missing, you should immediately contact your place of purchase for a speedy replacement.

About Safety

HEAD PROTECTION IS RECOMMENDED!

Working with or under heavy parts included with this shelter can cause serious head injury.

WEAR GLOVES

You will be working with metal parts which may have SHARP edges

CHECK WITH YOUR LOCAL AUTHORITIES

Underground POWER CABLES or GAS LINES may result in injury while securing the shelter. It may also result in having to move the building. A cursory check with the local building authorities will help alleviate these concerns.

CLIMBING EQUIPMENT

It is highly recommended that scaffolding, ladders and mechanical lifting equipment conform to all local building codes when erecting the shelter. Safety straps and harnesses should be used at all times. The metal structure of the shelter has not been designed for human weight. Erecting shelter during wind or rain is unsafe and could result in serious injury.

CHECK LOCAL WEATHER CONDITIONS

Check your local weather forecast prior to planning your building day. Wind, snow and/or rain may cause unsafe conditions that could lead to serious injury.

STORING HAZARDOUS MATERIALS

Check all local building codes prior to storing any hazardous material. Shelter may require additional ventilation to meet local codes.

SEVERE WEATHER CONDITIONS

Working in and around the portable shelter during severe weather is not recommended. Serious injury could result. In the event that extraordinarily severe wind, snow or other severe conditions are predicted and if time permits, it is recommended that the shelter cover be removed.

PREVENT ENTRAPMENT

Check Shelter for co workers before locking up. Always provide for escape in case of emergency.

SHELTER RELOCATION

Should the shelter require relocation or disassembly for any reason, it is strongly recommended that the structure and its cover are thoroughly inspected prior to rebuilding.

PERIODIC SHELTER INSPECTION

As with all structures, periodic inspection of the cover and all structural-components is highly recommended. Tightening the cover and the structure will prolong the life of your investment.

PLEASE BE **Safety** CONSCIOUS!





Common Sense is the knack of seeing things as they are, and doing things as they ought to be done.

THANK YOU FOR CHOOSING OUR SHELTER



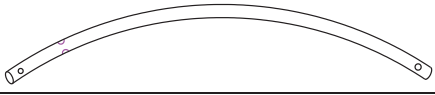
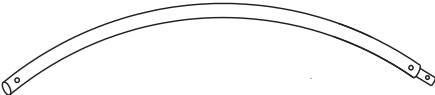

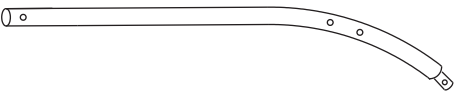
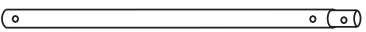
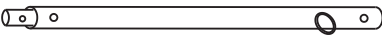
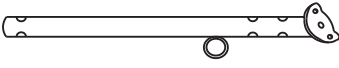
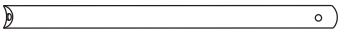
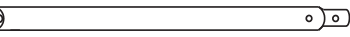
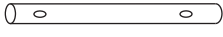
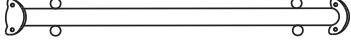
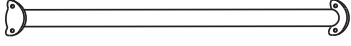
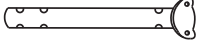
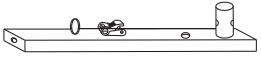
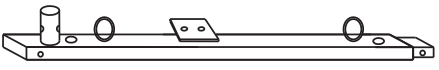
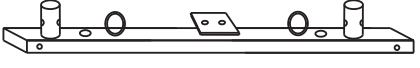

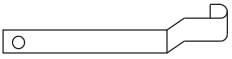



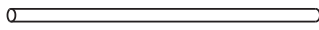

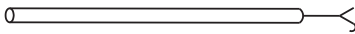

UNPACKING & IDENTIFYING PARTS

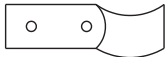
Prior to assembling your New Portable Shelter, unpack all crates and complete an inventory of all parts according to the following list and diagrams

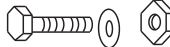

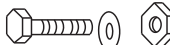
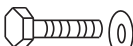
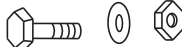

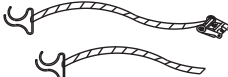
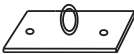
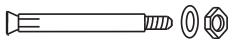
PARTS LIST FOR SH-RO44

Parts#	Descriptions	Diagram	Dimensions (in mm)	Q'TY
1	Roof arched rafter		Φ45x2100	2
2	Roof arched rafter		Φ45x2100	2
3	Roof arched rafter		Φ45x2100	2
4	Roof arched rafter(lower end)		Φ45x2100	2
5	Side upper curved rafter		Φ45x1240	8
6	Side vertical rafter(leg)		Φ45x1500	8
7	Door frame vertical tube(lower)		Φ45x1500	4
8	Door frame vertical tube(upper)		Φ45x1475	4
9	Upper door cross tube		Φ45x1505	2
10	Upper door cross tube		Φ45x1505	2
10-1	Door framesidecross support tube		Φ45x380	4
11	Purlin with rings		Φ38x1276	9
12	Purlin		Φ38x1276	6
13	Upper door vertical support		Φ45x880	2
14	Door frame base rail		25x70x450	4
15	Side base rail		25x70x1318	4
16	Side base rail		25x70x1403	2
17	Upper door vertical support connector		Φ45	2
18	Door sliding cable support hook		3x25	2

PARTS LIST FOR SH-RO44

Parts#	Descriptions	Diagram	Dimensions (in mm)	Q'TY
19	Cover conduit		Φ28x1340	2
20	Cover conduit		Φ28x1340	4
21	Zipper tool(open/close)		Φ16x1000	1
22	Fixer		Φ45	15
23	Door sliding cable (S:18pcs)		Φ6x3000	2
24	Roof bracing cable kit		Φ6x2330	12
25	Side wall bracing cable		Φ6x2630	12
26	Singleway clamp		Φ45	16
27	Anchor		M16x350	16
28	Screw kits		M8x75	92
29	Screw kits for door frame		M8x75	8
30	Screws for base rail		M8x100	6
31	Screws for door base		M8x100	4
32	Screw kits for ratchet		M8x15	12
33	Ratchet tie-down		3x30x75	6
34	Door wind bracing cable kit		Φ 6x3720	4
35	Roof wind bracing cable kits			3
36	Base for #35		8x60x150	6
37	Door Wedge anchor (#36)		M12x120	12
38	Strap band (for ratchet)		25x700	6
39	Cover locker-up ratchet		T-2	32

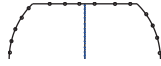
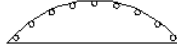
PARTS LIST FOR SH-RO44

Parts#	Descriptions	Diagram	Dimensions (in mm)	QTY
40	Ball Type Bungee		Φ 5x330	60
41	Main Cover			1
42	Door cover			2
43	Gable cover			2
44	Wrench		#13-16	2

PARTS LIST FOR SH-RO44

L4 x W4x H3.55m SH-RO44

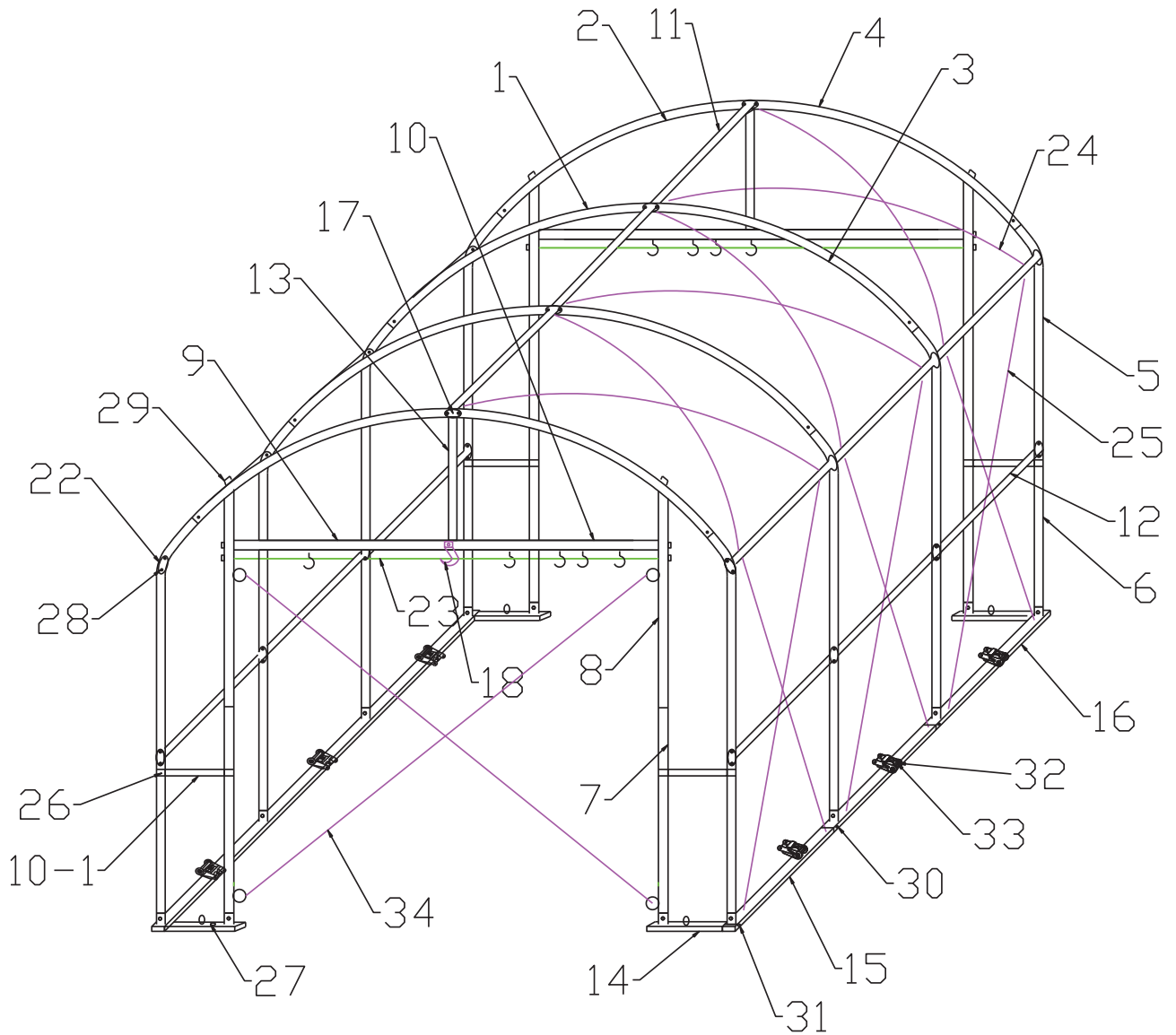

SH-RO44 Main Dimension(mm)

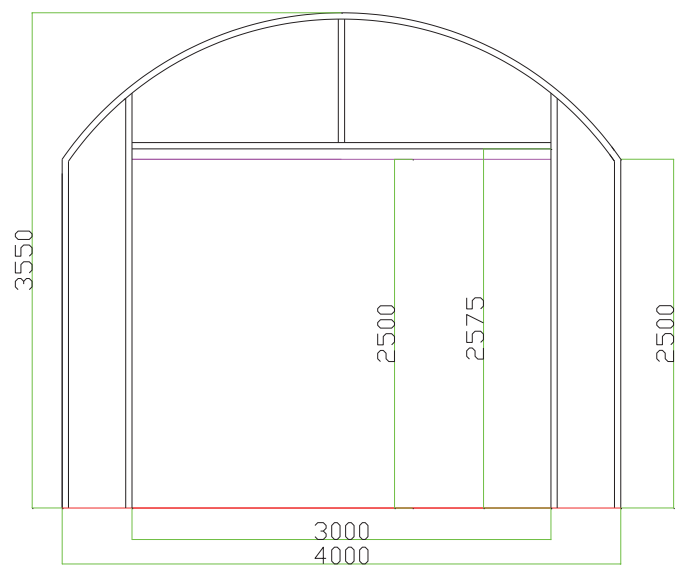
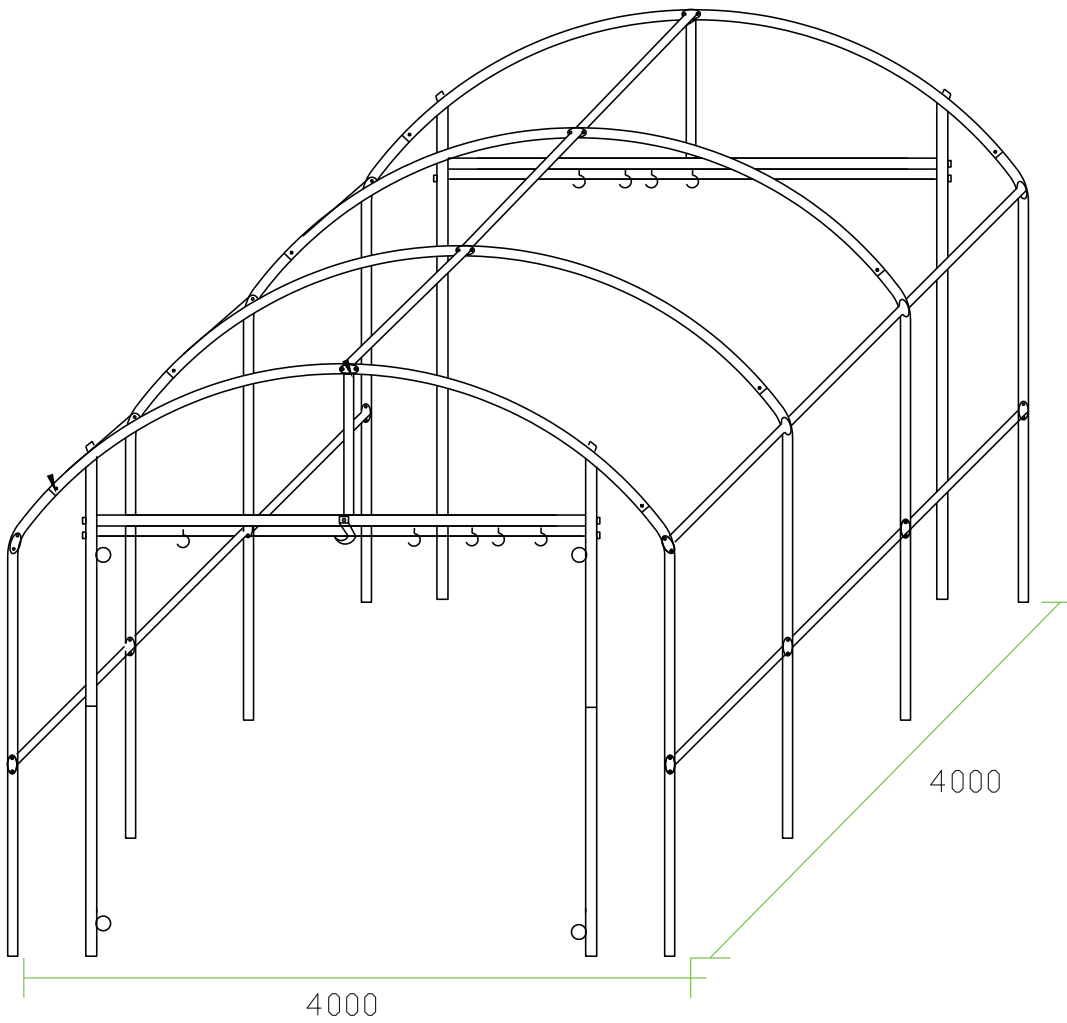

※サイズは約です。必ず現物で合わせてください。

Base drawing

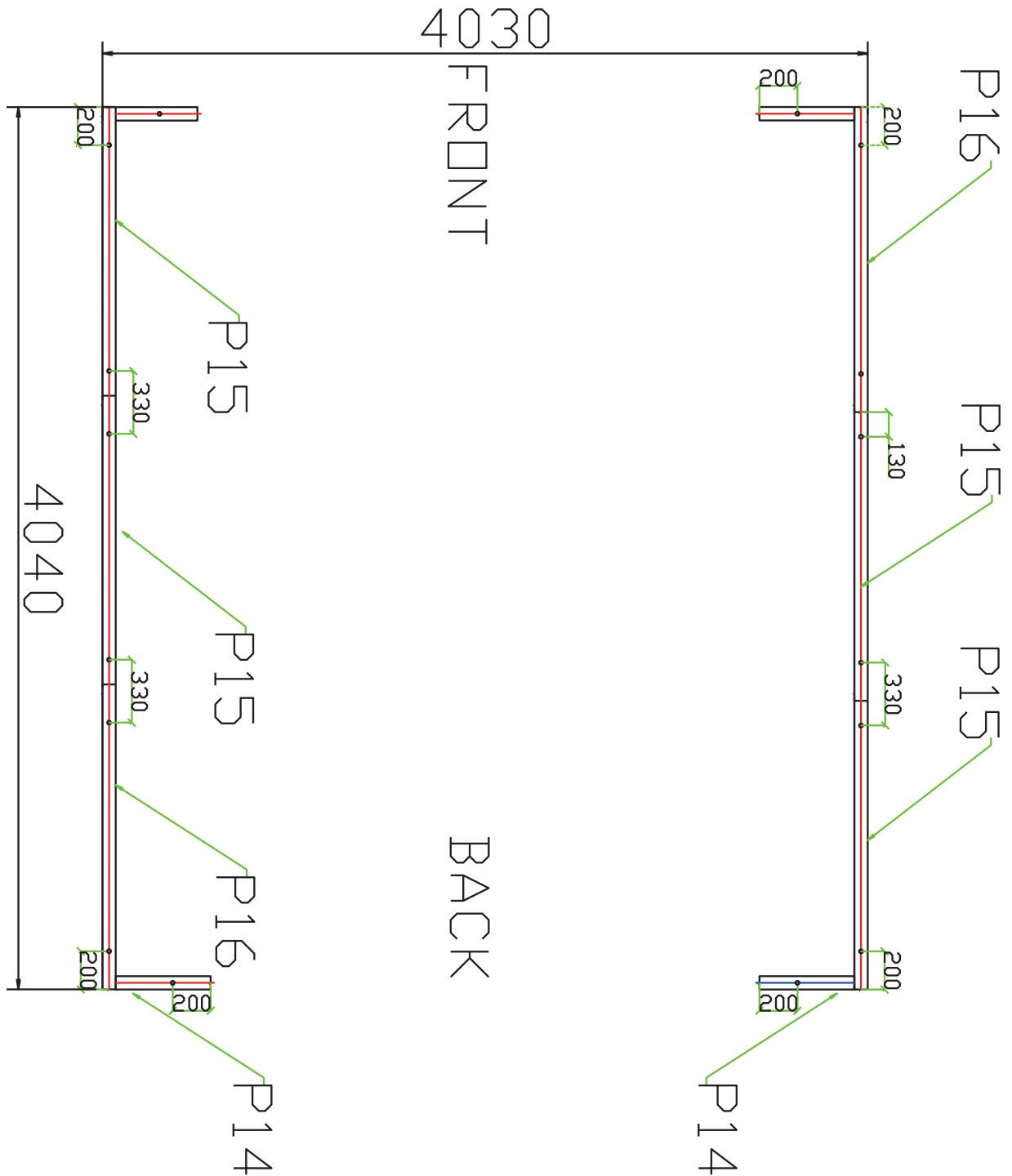

※サイズは約です。必ず現物で合わせてください。

Frame Assembly Steps

Step 1: Place and connect the base #15, #16, #17, fix to ground with #27 and fasten.

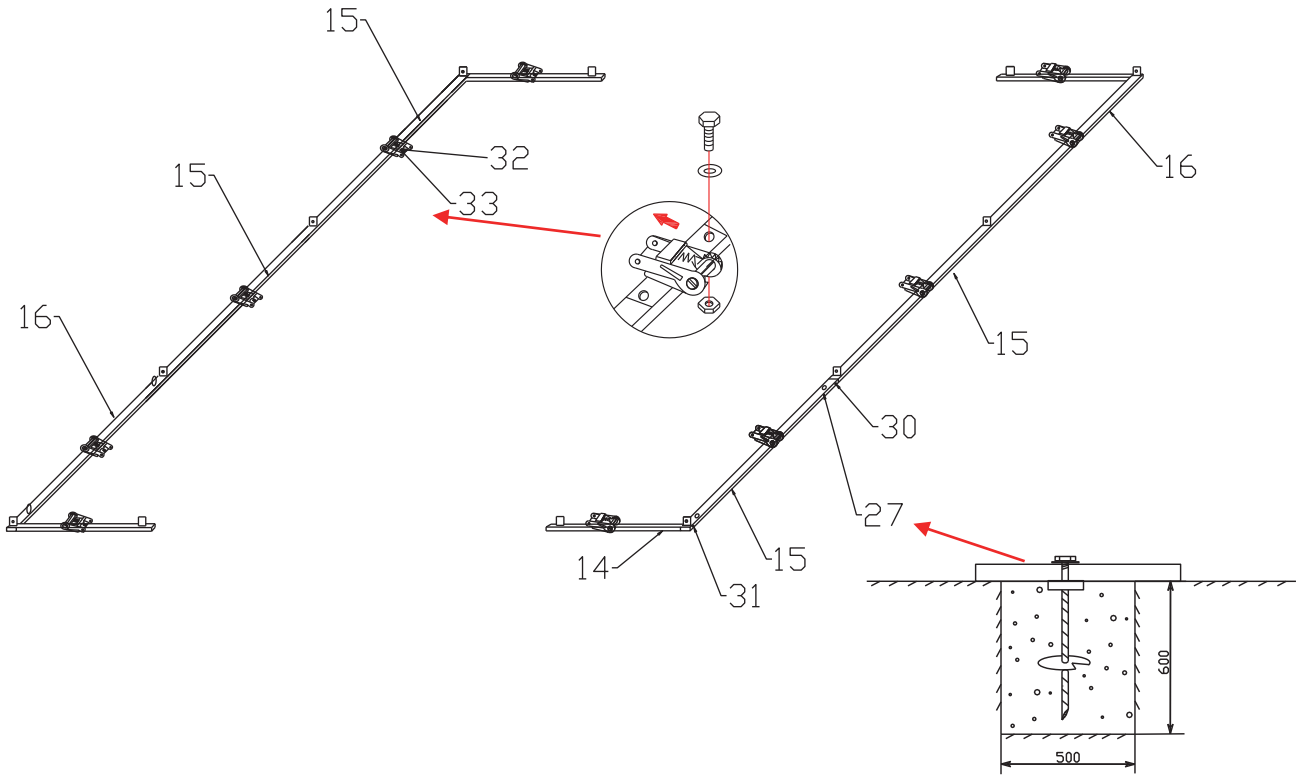

Step 2: Install the end rafters #2,#4 and #5,#6 (To avoid accident, It is very important to hold the first row of rafter with support (wood, rope or similar stuffs), make sure that it won't fall down.)

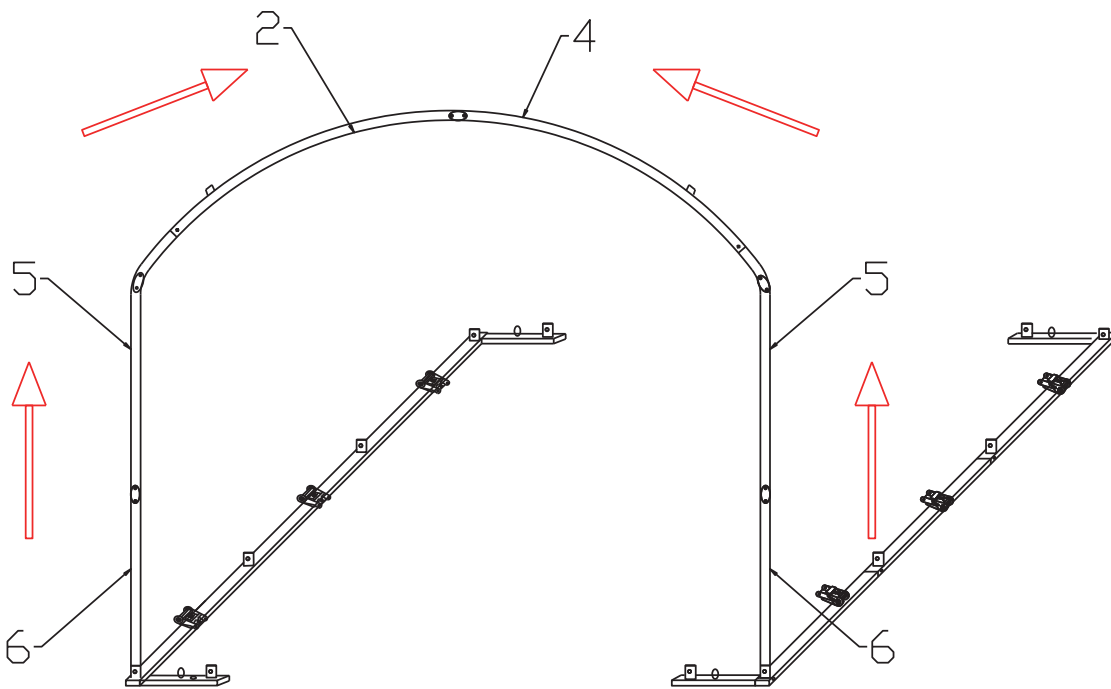

Covering Your World

Step 3: Install the second row of rafters #1, #3 and #5, #6, put into feet and connect with end rafters with #11, #12, then brace with #24, #25.

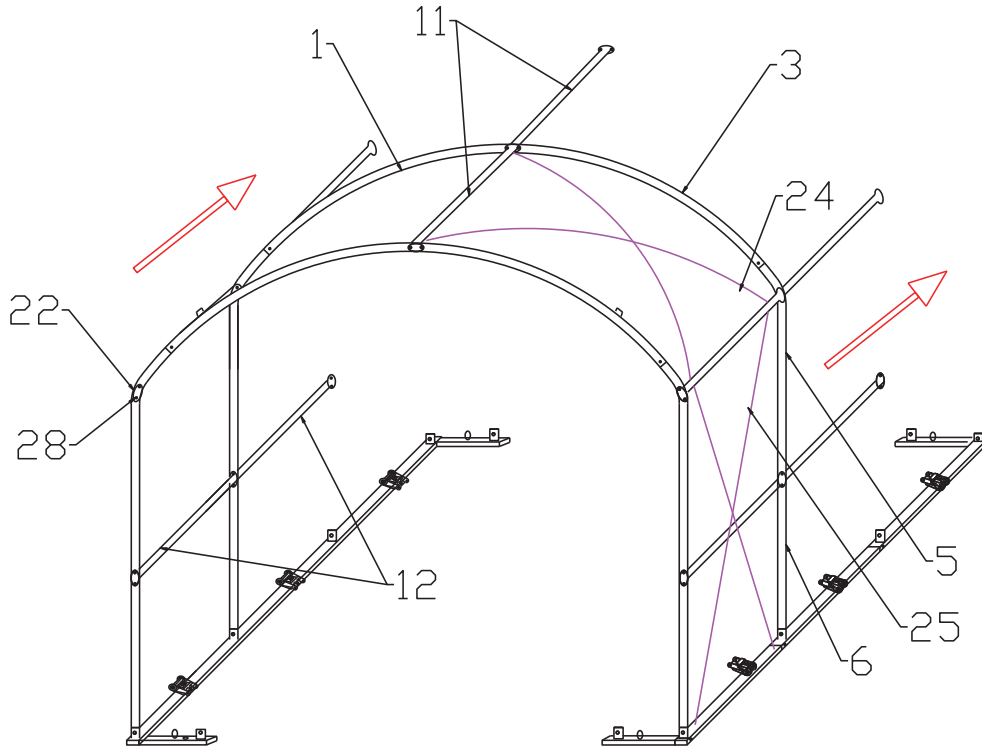

Step 4: The same way to install other rows of rafters.

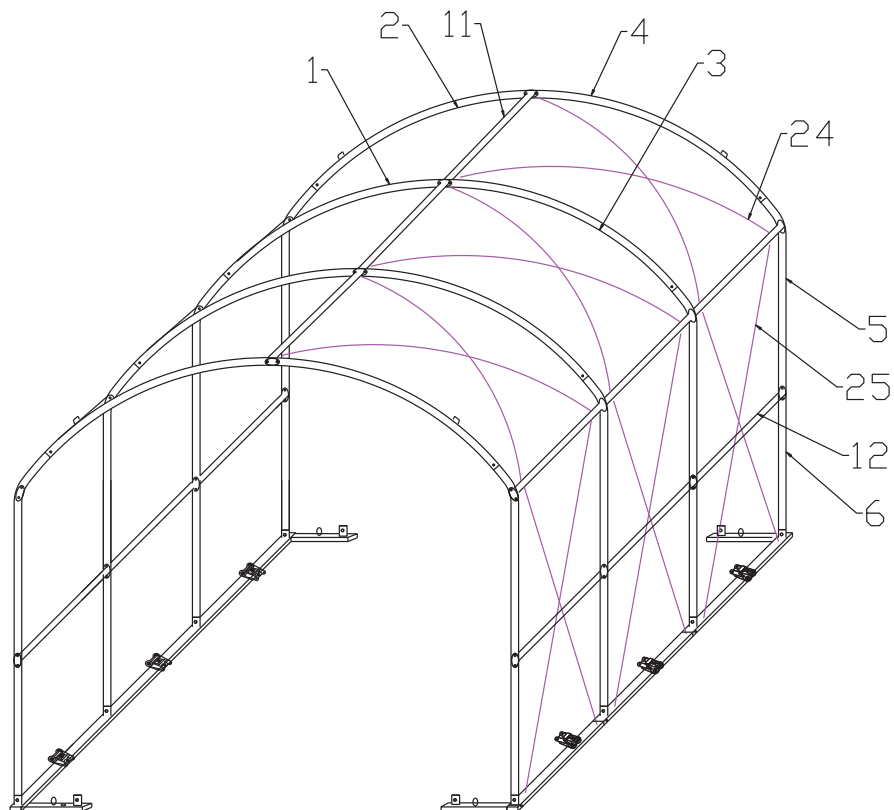

Covering Your World

Step5: Install the door frames as illustrated below, then fasten all the screws and parts.

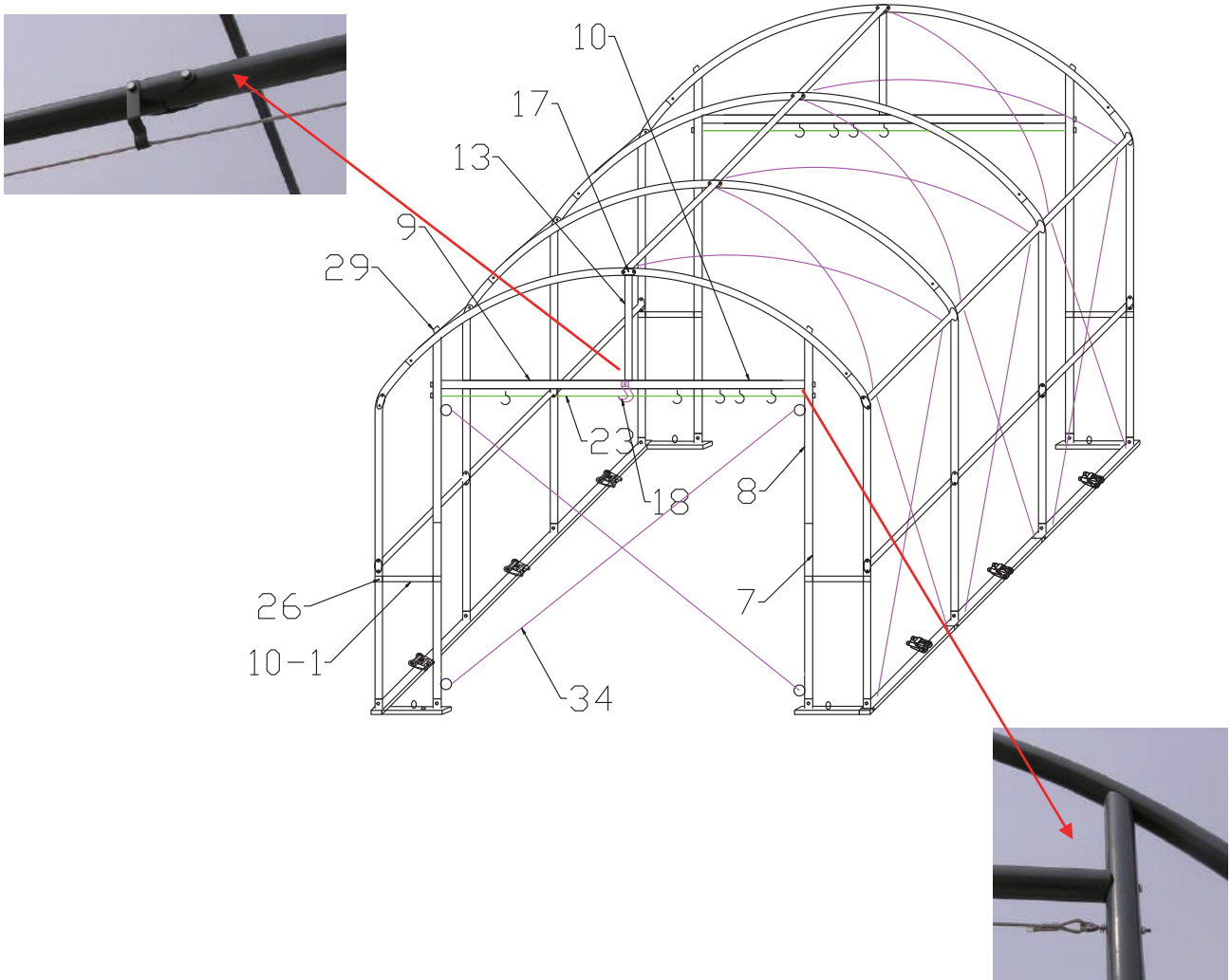

Tips: The tools below may needed while installing the shelter.

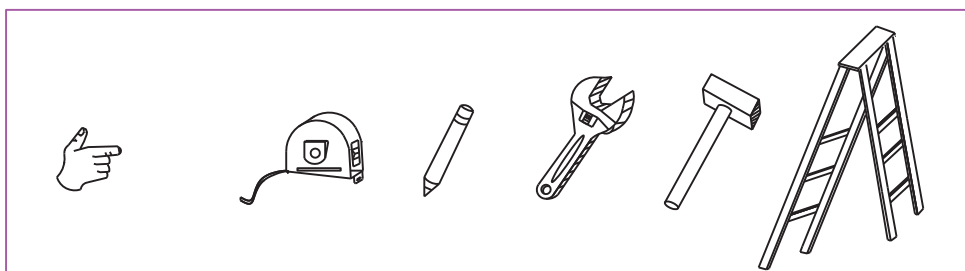

Roof Cover Assembly

TIPS : Slide the roof cover over assembled frame from one side

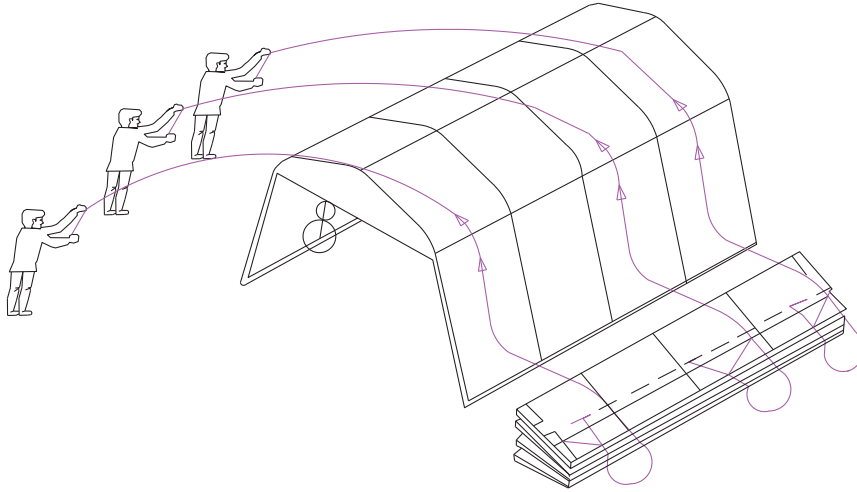

insert the conduit to pocket on side:

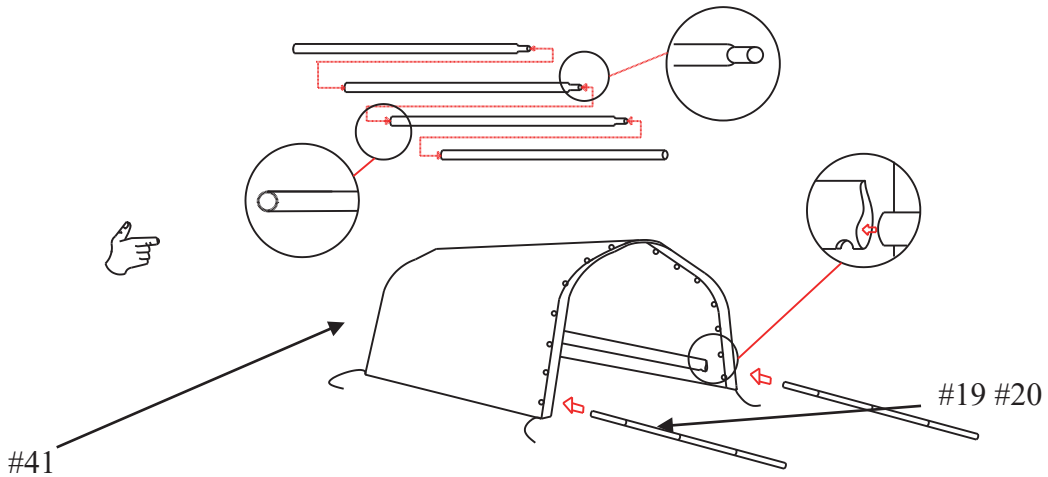

Pocket for side wall conduit
Ratchet tie down for tensioning the Side wall (roof cover)

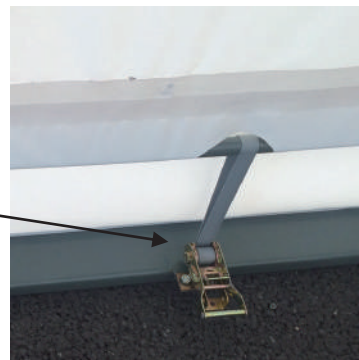
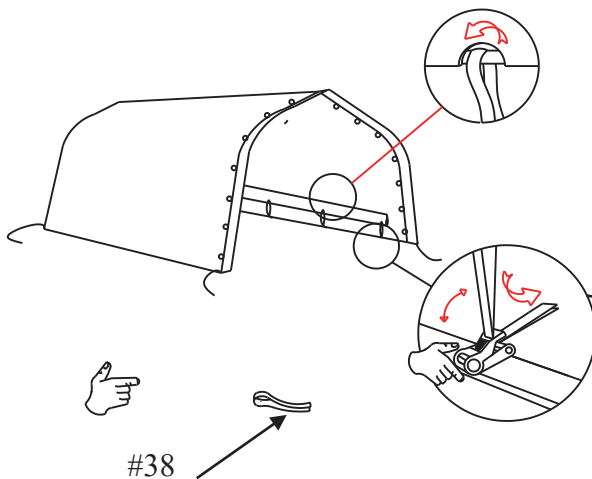

Covering Your World

Step 2 : Attach the cover (#35/#36) to the frame as following :

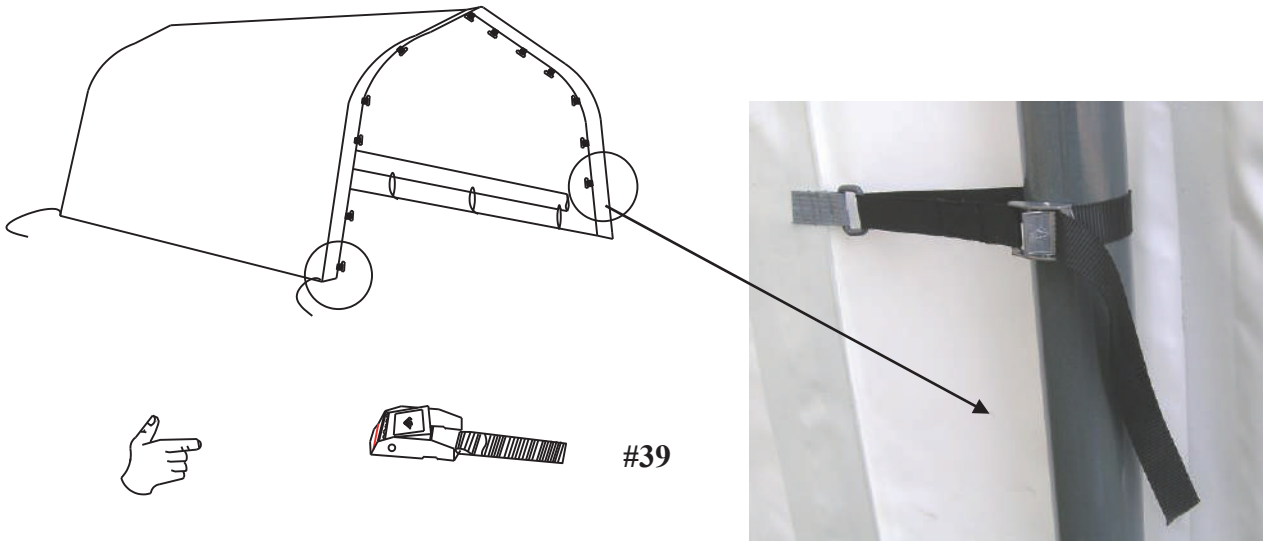

Note:#39 for main roof cover tensioning.
#40 for front and end covers tensioning.

Your assembled shelter will be similar to the illustration as below :

Illustration for Ratchet

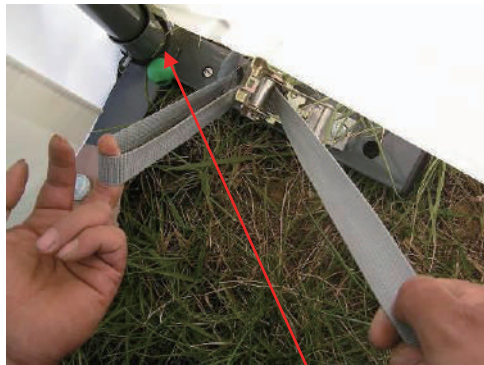

#40



#42 #43

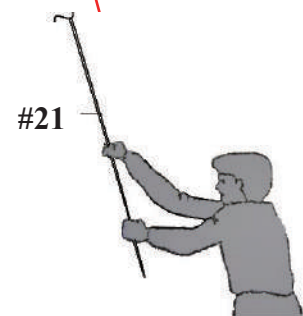

#21

(in order to protect the shelter from heavy wind, please install the wind bracing straps at points 300 mm measuring from the ends, and others to be installed in the middle averagely.) (photos are for reference only, the real quantity is according to packing list.)

